

Part number

CAP 16 L2



Surface mounting housing, C-TYPE series, with 1 lever, Pg21 x 2 cable entry, size "77.27", high construction

| Product description | | Material properties | |
|---|------------------------------|-------------------------------------|---|
| Product type | Surface mounting housing | Other materials | Lever: Stainless steel, polyamide (PA) Gasket: NBR |
| Series | C-TYPE | Colour | RAL 7040 grey |
| Closing type | With 1 lever | RoHs conformity | Compliant |
| Size | Size 77.27 | China RoHs - EFUP | E |
| Cable entry | With cable entry Pg21 x 2 | REACH SVHC substances | No |
| Specification | High construction | Approvals / Standards | |
| Technical data | | Certifications | DNV, BV |
| IP degree of protection | IP65 / IP66 / IP69 | UL | ECBT2 |
| Further technical details | | cUL | ECBT8 |
| Weight | 420,00 g | General ordering information | |
| Operating temperature range (min, max) | -40°C...+125°C | EAN13 code | 8015747008068 |
| | | Packaging Information | |
| | | Packaging length | 475,00 mm |
| | | Packaging height | 220,00 mm |
| | | Packaging width | 175,00 mm |
| | | Packaging weight | 4,57 kg |
| | | Packaging volume | 18,29 dm ³ |
| | | Packaging description | Carton box |
| | | Packaging quantity | 10 Pcs |
| | | Packaging EAN code | 8015747236645 |
| | | Sub-packaging weight | 2,29 kg |
| | | Sub-packaging description | Plastic packaging |
| | | Sub-packaging quantity | 5 Pcs |
| | | Sub-packaging EAN barcode | 8015747008075 |

Part number

CAP 16 L2



Catalogue drawings

CHP L CAP L - MHP L MAP L



CHP LS CAP LS - MHP LS MAP LS

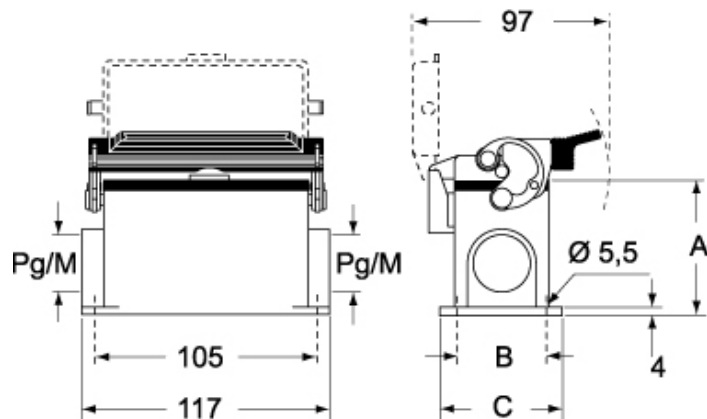

| | A |
|------------------------|----------|
| CHP L / MHP L | 63 |
| CAP L / MAP L | 77 |
| CHP LS / MHP LS | 63 |
| CAP LS / MAP LS | 77 |