

Part number

CAO 16 X29



Hood, C-TYPE series, with 2 levers, Pg29 side cable entry, size "77.27", high construction, without gasket

Product description

Product type	Hood
Series	C-TYPE
Closing type	With 2 levers
Size	Size 77.27
Cable entry	Side cable entry Pg29
Specification	High construction, without gasket

Technical data

IP degree of protection	IP65 / IP66 / IP69
--------------------------------	--------------------

Further technical details

Weight	315,00 g
Operating temperature range (min, max)	-40°C...+125°C

Material properties

Other materials	Lever: Stainless steel, polyamide (PA)
Colour	RAL 7040 grey
RoHs conformity	Compliant
China RoHs - EFUP	E
REACH SVHC substances	No

Approvals / Standards

Certifications	DNV, BV
UL	ECBT2
cUL	ECBT8

General ordering information

EAN13 code	8015747006309
-------------------	---------------

Packaging Information

Packaging length	250,00 mm
Packaging height	145,00 mm
Packaging width	300,00 mm
Packaging weight	3,15 kg
Packaging volume	10,88 dm ³
Packaging description	Carton box
Packaging quantity	10 Pcs
Packaging EAN code	8015747215589
Sub-packaging weight	1,58 kg
Sub-packaging description	Plastic packaging
Sub-packaging quantity	5 Pcs
Sub-packaging EAN barcode	8015747006316

Part number

CAO 16 X29



Catalogue drawings

CHO X (CAO X) - MHO X (MAO X)

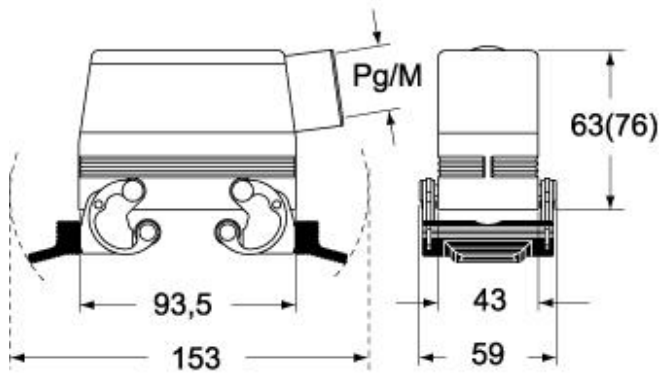

CHV X (CAV X) - MHV X (MAV X)

