

Part number

BK 32104



Interlocked switched socket-outlet, BK series, 3 poles + PE, 10 h (green), 32 A, > 50 V, sectionable fuse carrier 10 x 38 mm

Product description	
Product type	Interlocked switched socket-outlet
Series	BK
N. of poles	3 poles +
Clock position	10
Specification	Sectionable fuse carrier 10 x 38 mm
Technical data	
Current	32 A
Voltage	> 50 V
IP degree of protection	IP67
Further technical details	
Weight	1.400,00 g
Operating temperature range (min, max)	-25°C ... +40°C
IK rating (impact degree of protection)	IK10

Material properties	
Colour	RAL 7035 grey, RAL 6017 green
RoHs conformity	Compliant with exemption 6(c): copper alloy containing up to 4% lead by weight
China RoHs - EFUP	50
REACH SVHC substances	Yes Lead
SCIP number	F6799547-ab84-42f2-938f-233ba663766d
Approvals / Standards	
Reference standard	EN 60309-1, -2 e -4
General ordering information	
EAN13 code	8015747004664
Packaging Information	
Sub-packaging length	116,00 mm
Sub-packaging height	130,00 mm
Sub-packaging width	230,00 mm
Sub-packaging weight	1,40 kg
Sub-packaging volume	3,47 dm ³
Sub-packaging description	Carton box
Sub-packaging quantity	1 Pcs
Sub-packaging EAN barcode	8015747004688

Part number

BK 32104



Catalogue drawings

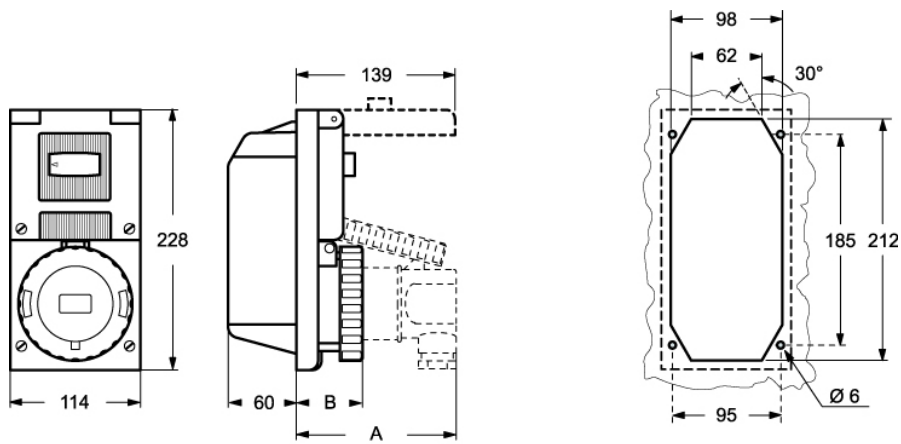

BK		A	B
16A	2P + ⊕	105	50
	3P + ⊕	105	50
	3P + N + ⊕	110	50
32A	2P + ⊕	140	58
	3P + ⊕	140	58
	3P + N + ⊕	140	58