

Part number

AH M32IFL



Complete cable gland, M32, for diameter 20-23 mm

Product description		General ordering information	
Product type	Complete cable gland	EAN13 code	8015747262897
Cable entry	M32	eCl@ss 8.1	27149109
Specification	For diameter 20-23 mm For T-TYPE HYGIENIC	ETIM 7.0	EC000441
Technical data		Packaging Information	
IP degree of protection	IP68/IP69	Sub-packaging weight	0,21 kg
Further technical details		Sub-packaging description	Plastic packaging
Weight	42,80 g	Sub-packaging quantity	5 Pcs
Operating temperature range (min, max)	-20 °C...+85 °C	Sub-packaging EAN barcode	8015747262934

Part number

AH M32IFL



Catalogue drawings

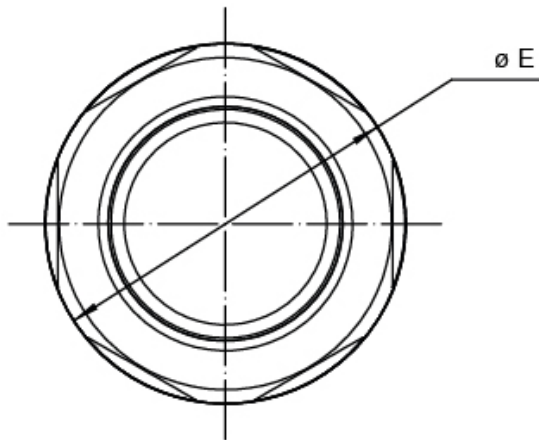
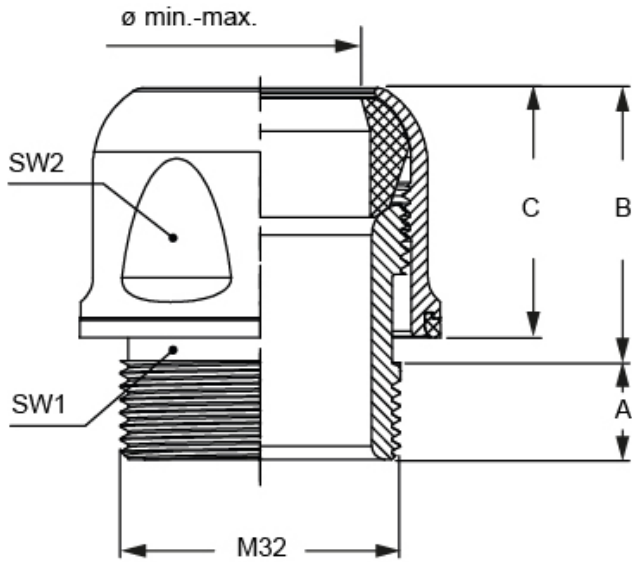

part No.	A	B	C	SW1	SW2	ø E	ø min.-max.
AH M32IF	11	32	28	30	38	40,9	18,0-21,0
AH M32IFL	11	32	28	30	38	40,9	20,0-23,0