

Part number

TMAP10.232B



Surface mounting housing, T-TYPE series, with 2 levers, M32 cable entry, size "57.27", with integrated protective PE jumpers

Product description	
Product type	Surface mounting housing
Series	T-TYPE
Closing type	With 2 levers
Size	Size 57.27
Cable entry	With cable entry M32 x 2
Specification	With integrated protective PE jumpers
Technical data	
IP degree of protection	IP65
Further technical details	
Weight	165,50 g
Operating temperature range (min, max)	-40°C ... +90°C

Material properties	
Main material	Polypropylene (PP)
Other materials	Lever: Polyamide (PA) Gasket: polyurethane (PUR) PE jumpers: galvanized brass
Colour	RAL 7012 grey, RAL 7001 grey
RoHs conformity	Compliant
China RoHs - EFUP	E
REACH SVHC substances	No
Approvals / Standards	
UL	ECBT2
cUL	ECBT8
General ordering information	
EAN13 code	8015747277297
Packaging Information	
Packaging length	310,00 mm
Packaging height	220,00 mm
Packaging width	240,00 mm
Packaging weight	3,63 kg
Packaging volume	16,37 dm ³
Packaging description	Carton box
Packaging quantity	20 Pcs
Packaging EAN code	8015747178822
Sub-packaging weight	0,91 kg
Sub-packaging description	Plastic packaging
Sub-packaging quantity	5 Pcs
Sub-packaging EAN barcode	8015747179270

Part number

TMAP10.232B



Catalogue drawings

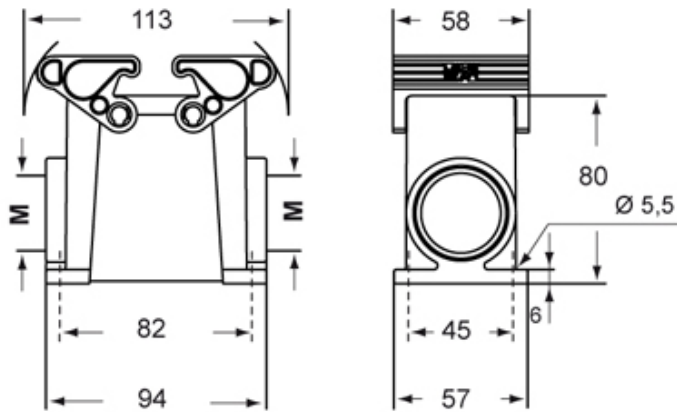

Notes