

Part number

TAVC06LG32B



Hood, T-TYPE/C series, with 1 lever, M32 top cable entry, size "44.27", with integrated protective PE jumpers

Product description	
Product type	Hood
Series	T-TYPE/C
Closing type	With 1 lever
Size	Size 44.27
Cable entry	Top cable entry M32
Specification	With integrated protective PE jumpers
Technical data	
IP degree of protection	IP66 / IP69
Further technical details	
Weight	0,50 g
Operating temperature range (min, max)	-50°C ... +70°C

Material properties	
Main material	Polypropylene (PP)
Other materials	Lever: Polypropylene (PP) Gasket: Silicone rubber PE jumpers: galvanized brass
Colour	RAL 7012 grey, RAL 5005 blue
RoHs conformity	Compliant
China RoHs - EFUP	E
REACH SVHC substances	No
General ordering information	
EAN13 code	8015747278393
Packaging Information	
Packaging length	305,00 mm
Packaging height	180,00 mm
Packaging width	275,00 mm
Packaging description	Carton box
Packaging quantity	20 Pcs
Packaging EAN code	8015747300681
Sub-packaging description	Plastic packaging
Sub-packaging quantity	5 Pcs
Sub-packaging EAN barcode	8015747300698

Part number

TAVC06LG32B



Catalogue drawings

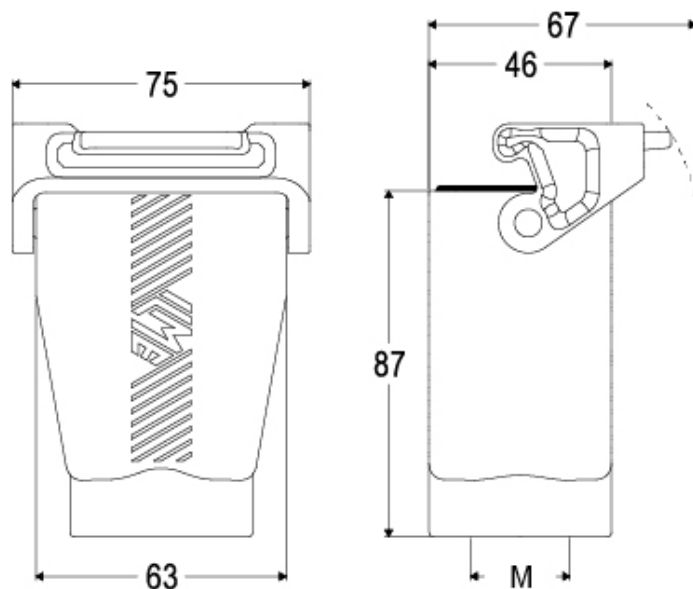

Notes