

Part number

TAPH 24.32B



Surface mounting housing, T-TYPE /H series, with 2 levers, M32 cable entry, size "104.27", with integrated protective PE jumpers

Product description		Material properties	
Product type	Surface mounting housing	Main material	Polypropylene (PP)
Series	T-TYPE /H	Other materials	Lever: Polypropylene (PP), metal-detectable Gasket: HNBR PE jumpers: galvanized brass
Closing type	With 2 levers	Colour	RAL 7012 grey, RAL 5005 blue
Size	Size 104.27	RoHs conformity	Compliant
Cable entry	With cable entry M32	China RoHs - EFUP	E
Specification	With integrated protective PE jumpers	REACH SVHC substances	No
Technical data		General ordering information	
IP degree of protection	IP66 / IP69	EAN13 code	8015747278065
Further technical details		Packaging Information	
Weight	0,50 g	Packaging length	330,00 mm
Operating temperature range (min, max)	-40°C ... +70°C	Packaging height	220,00 mm
		Packaging width	310,00 mm
		Packaging volume	22,51 dm ³
		Packaging description	Carton box
		Packaging quantity	20 Pcs
		Packaging EAN code	8015747065603
		Sub-packaging description	Plastic packaging
		Sub-packaging quantity	5 Pcs
		Sub-packaging EAN barcode	8015747064095

Part number

TAPH 24.32B



Catalogue drawings

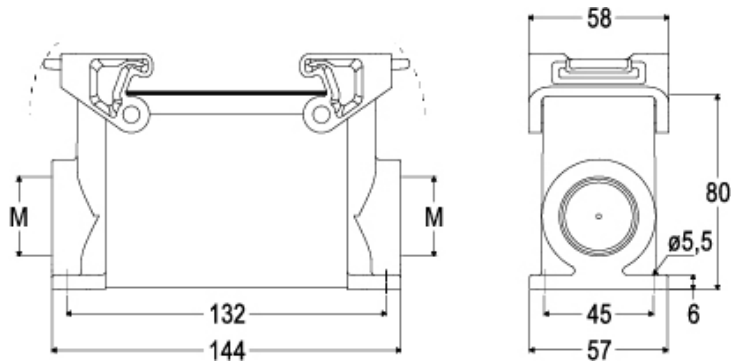

Notes