

Part number

# TAPH 10.225



Surface mounting housing, T-TYPE /H series,  
with 2 levers, M25x2 cable entry, size "57.27"

#### Product description

<b>Product type</b>	Surface mounting housing
<b>Series</b>	T-TYPE /H
<b>Closing type</b>	With 2 levers
<b>Size</b>	Size 57.27
<b>Cable entry</b>	With cable entry M25 x 2

#### Technical data

**IP degree of protection** IP66 / IP69

#### Further technical details

**Operating temperature range (min, max)** -40°C ... +70°C

#### Material properties

<b>Main material</b>	Polypropylene (PP)
<b>Other materials</b>	Lever: Polypropylene (PP), metal-detectable Gasket: HNBR
<b>Colour</b>	RAL 7012 grey, RAL 5005 blue
<b>RoHs conformity</b>	Compliant
<b>China RoHs - EFUP</b>	E
<b>REACH SVHC substances</b>	No

#### General ordering information

<b>EAN13 code</b>	8015747185011
<b>eCl@ss 8.1</b>	27440202
<b>ETIM 7.0</b>	EC000437

Part number

# TAPH 10.225



Catalogue drawings

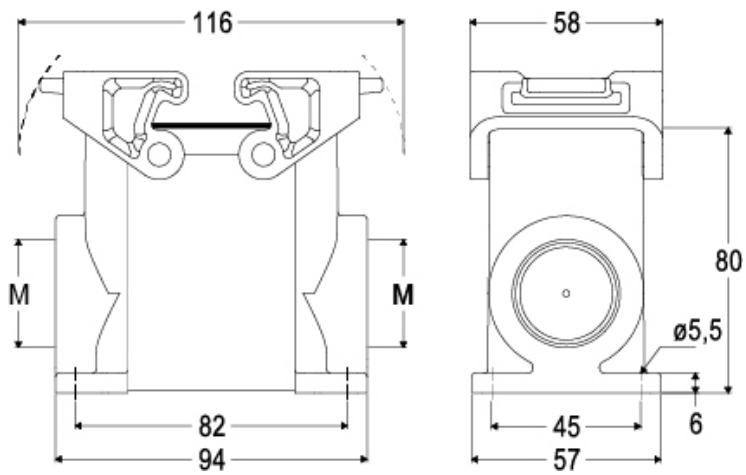

Notes