

Part number

SIM3D 0.2

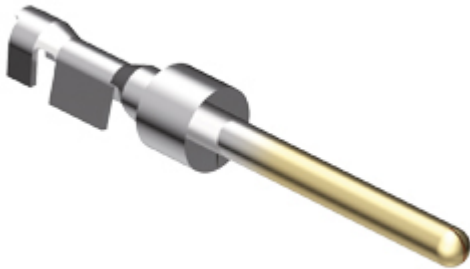

Male crimp contact, SI series, 5 A, stamped gold plated, wire cross section 0,08 - 0,21 mm², AWG 28 - 24, loose parts, for 50 mating cycles

Product description

Product type	Crimp contact
Series	SI
Gender	Male
Specification	Loose parts For 50 mating cycles

Technical data

Current	5 A
Wire cross-section	0,08 mm ² - 0,21 mm ²
AWG size	28 - 24
Contact type	Stamped gold plated

Further technical details

Contact resistance	≤ 10 mΩ
Weight	0,09 g
Conductors stripping length	3 mm

Material properties

RoHS conformity	Compliant
China RoHS - EFUP	E
REACH SVHC substances	No

Approvals / Standards

Certifications	EAC
UL	ECBT2
cUL	ECBT8

General ordering information

EAN13 code	8015747276924
eCl@ss 8.1	27440204
ETIM 7.0	EC000796

Packaging Information

Packaging length	112,00 mm
Packaging height	95,00 mm
Packaging width	117,00 mm
Packaging weight	0,32 kg
Packaging volume	1,24 dm ³
Packaging description	Carton box
Packaging quantity	1600 Pcs
Packaging EAN code	8015747282260
Sub-packaging length	50,00 mm
Sub-packaging height	44,00 mm
Sub-packaging width	50,00 mm
Sub-packaging weight	0,04 kg
Sub-packaging volume	0,11 dm ³
Sub-packaging description	Plastic box
Sub-packaging quantity	200 Pcs
Sub-packaging EAN barcode	8015747282277

Part number

SIM3D 0.2



Catalogue drawings

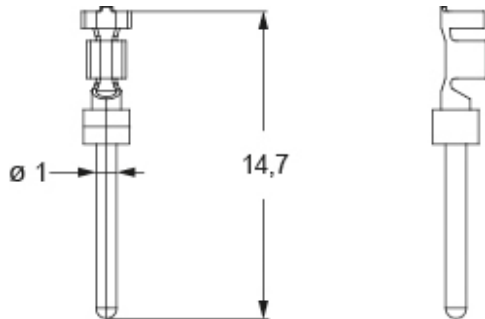

Notes

California Proposition 65 Information



WARNING

This product can expose you to nickel compounds, known to the State of California to cause cancer and/or reproductive toxicity. For more information go to www.P65Warnings.ca.gov.