

Part number

PK 6373 EB



Interlocked switched socket-outlet, PK series, 2 poles + PE, 7 h (black), 63 A, 480 ÷ 500 V, without fuse-carrier

Product description

Product type	Interlocked switched socket-outlet
Series	PK..EB
N. of poles	2 poles + 
Clock position	7
Cable entry	Pg29
Specification	Without fuse-carrier

Technical data

Current	63 A
Voltage	480 ÷ 500 V
IP degree of protection	IP44

Further technical details

Operating temperature range (min, max)	-25°C ... +40°C
IK rating (impact degree of protection)	IK10

Material properties

Colour	RAL 7035 grey, RAL 9005 black
---------------	-------------------------------

Approvals / Standards

Reference standard	EN 60309-1, -2 e -4
---------------------------	---------------------

General ordering information

EAN13 code	8015747159104
-------------------	---------------

Part number

PK 6373 EB



Catalogue drawings

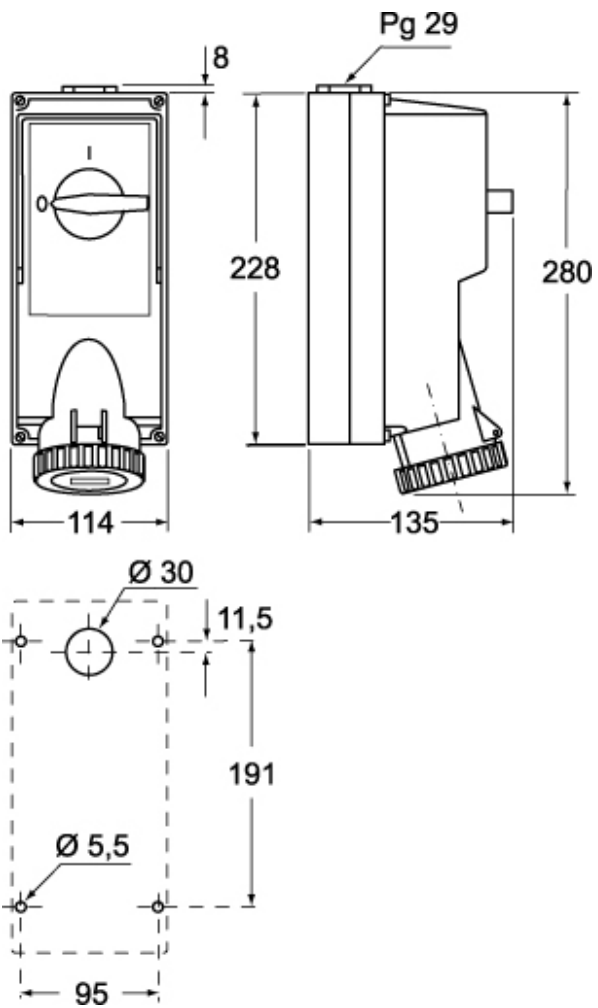

Notes