

Part number

# PK 6344 LL



Socket-outlet with circuit breaker and electrical interlock, PK series, 3 poles + PE, 4 h (yellow), 63 A, 100 ÷ 130 V

#### Product description

<b>Product type</b>	Socket-outlet with circuit breaker and electrical interlock
<b>Series</b>	PK..LL
<b>N. of poles</b>	3 poles + 
<b>Clock position</b>	4

#### Technical data

<b>Current</b>	63 A
<b>Voltage</b>	100 ÷ 130 V
<b>IP degree of protection</b>	IP55

#### Further technical details

<b>Weight</b>	8.500,00 g
<b>Operating temperature range (min, max)</b>	-25°C ... +40°C
<b>IK rating (impact degree of protection)</b>	IK10

#### Material properties

<b>Colour</b>	RAL 7035 grey, RAL 1021 yellow
---------------	--------------------------------

#### Approvals / Standards

<b>Reference standard</b>	EN 60309-1, -2 e -4
---------------------------	---------------------

#### General ordering information

<b>EAN13 code</b>	8015747082280
-------------------	---------------

#### Packaging Information

<b>Packaging description</b>	Carton box
<b>Packaging quantity</b>	1 Pcs
<b>Packaging EAN code</b>	8015747106849

Part number

# PK 6344 LL



Catalogue drawings

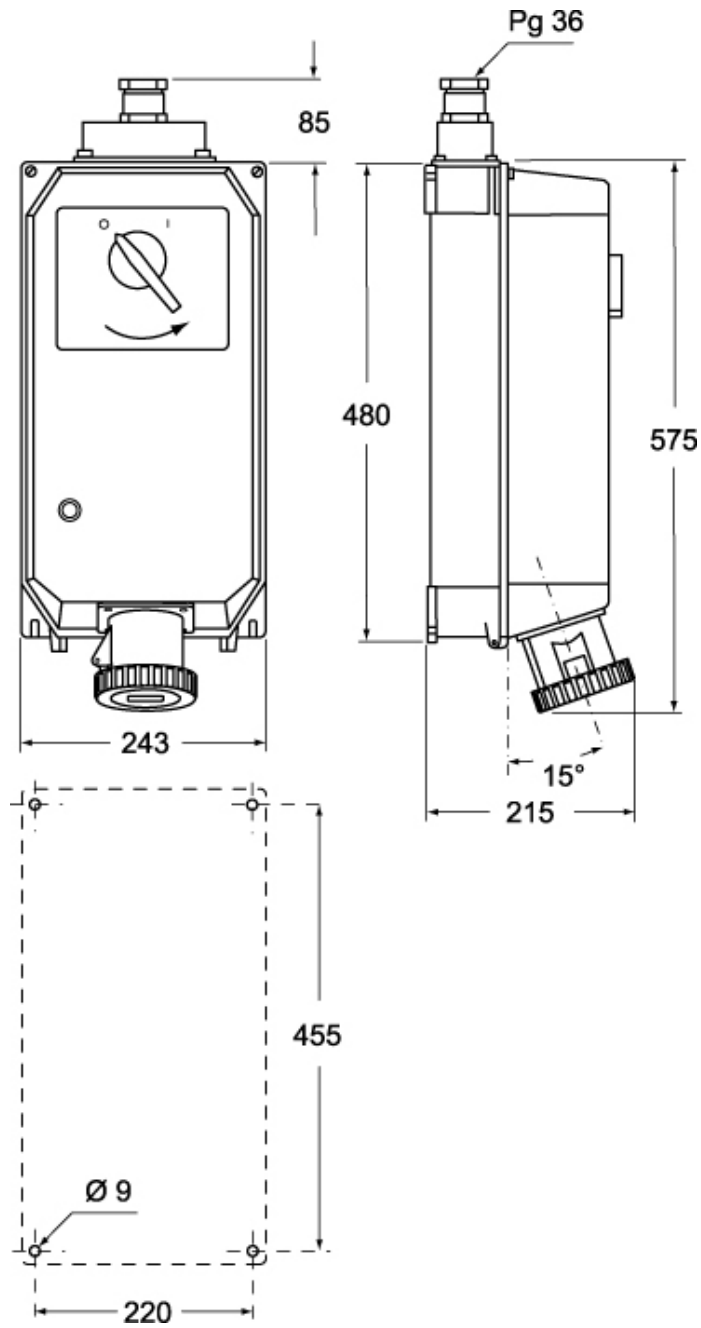

Notes