

Part number

PK 63123 LL



Socket-outlet with circuit breaker and electrical interlock, PK series, 2 poles + PE, 12 h (white), 63 A

Product description

Product type	Socket-outlet with circuit breaker and electrical interlock
Series	PK..LL
N. of poles	2 poles + 
Clock position	12

Technical data

Current	63 A
Voltage	ins. transformer
IP degree of protection	IP55

Further technical details

Operating temperature range (min, max)	-25°C ... +40°C
IK rating (impact degree of protection)	IK10

Material properties

Colour	RAL 7035 grey, RAL 9010 white
---------------	-------------------------------

Approvals / Standards

Reference standard	EN 60309-1, -2 e -4
---------------------------	---------------------

General ordering information

EAN13 code	8015747159029
-------------------	---------------

Part number

PK 63123 LL



Catalogue drawings

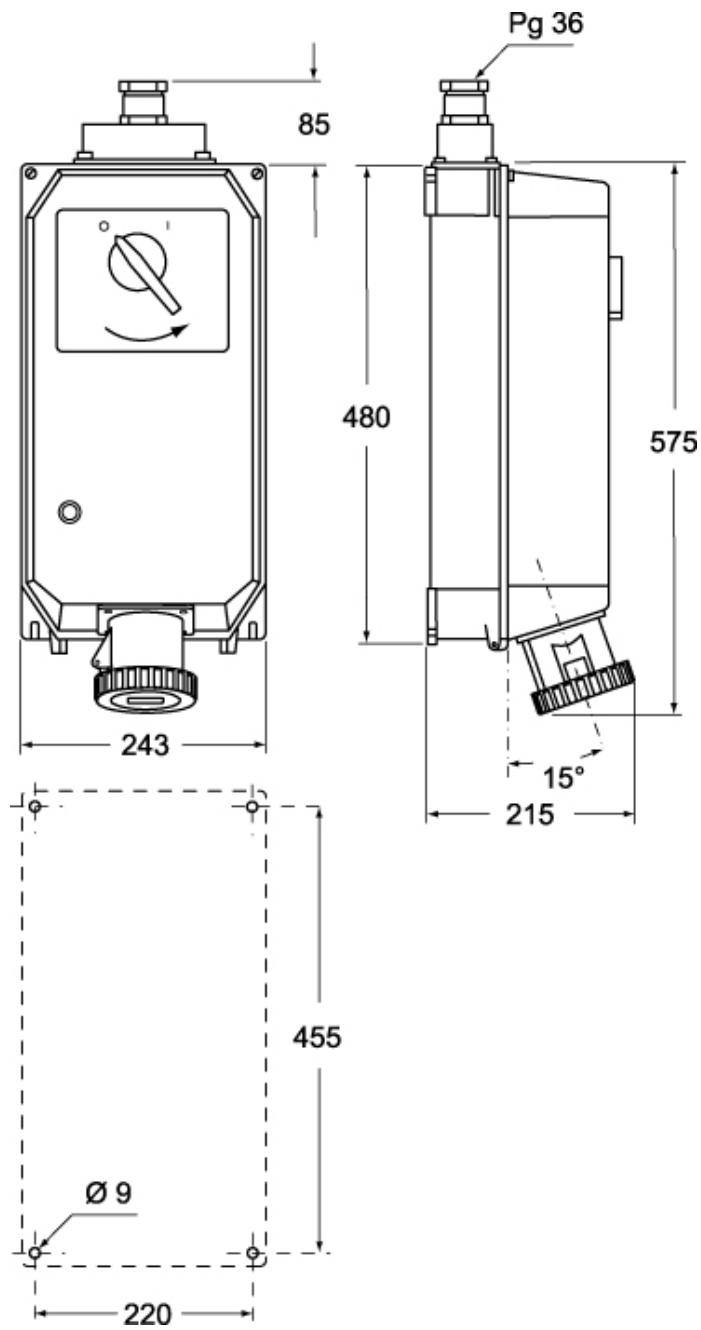

Notes