

Part number

PEW 6354 PP



Wall-mounting socket outlet, PLUSO series, 3 poles + PE, 5 h (black), 63 A, 600 ÷ 690 V

Product description

Product type	Socket Wall-mounting
Series	PEW...PP, PLUSO
N. of poles	3 poles + 
Clock position	5

Technical data

Current	63 A
Voltage	600 ÷ 690 V
IP degree of protection	IP67

Further technical details

Weight	1.343,00 g
Operating temperature range (min, max)	-25°C ... +40°C

Material properties

Colour	RAL 7035 grey, RAL 9005 black
RoHs conformity	Compliant with exemption 6(c): copper alloy containing up to 4% lead by weight
China RoHs - EFUP	50
REACH SVHC substances	Yes Lead
SCIP number	Ca7de37f-add8-4b77-9861-279c94903ade

Approvals / Standards

Reference standard	EN 60309-1 and -2
---------------------------	-------------------

General ordering information

EAN13 code	8015747077187
-------------------	---------------

Packaging Information

Packaging length	210,00 mm
Packaging height	135,00 mm
Packaging width	280,00 mm
Packaging weight	1,60 kg
Packaging volume	7,94 dm ³
Packaging description	Carton box
Packaging quantity	1 Pcs
Packaging EAN code	8015747077194

Part number

PEW 6354 PP



Catalogue drawings

(63A) PEW ... PP

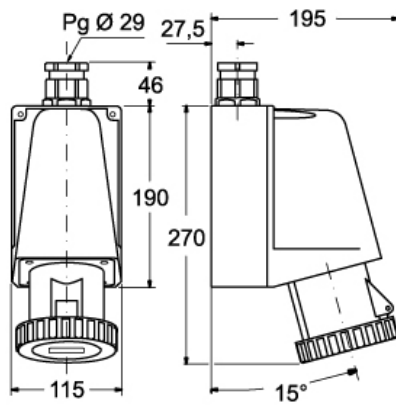

(125A) PEW ... PP

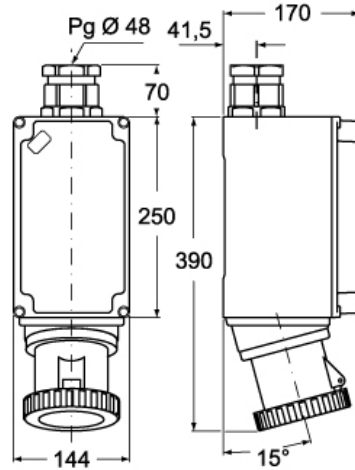

Notes