

Part number

PB 32002 PP



Wall-mounting socket outlet, PLUSO series, 2 poles, 32 A, 20 ÷ 25 V

Product description		Material properties	
Product type	Socket Wall-mounting	Colour	RAL 7035 grey, RAL 4001 lilac
Series	PB...PP, PLUSO	RoHs conformity	Compliant with exemption 6(c): copper alloy containing up to 4% lead by weight
N. of poles	2 poles	China RoHs - EFUP	50
Clock position	No key way	REACH SVHC substances	Yes Lead
Technical data		SCIP number	Ca7de37f-add8-4b77-9861-279c94903ade
Current	32 A	Approvals / Standards	
Voltage	20 ÷ 25 V	Reference standard	EN 60309-1 and -2
IP degree of protection	IP44	General ordering information	
Further technical details		EAN13 code	8015747061773
Weight	170,00 g	Packaging Information	
Operating temperature range (min, max)	-25°C ... +40°C	Packaging length	208,00 mm
		Packaging height	140,00 mm
		Packaging width	290,00 mm
		Packaging weight	1,92 kg
		Packaging volume	8,44 dm ³
		Packaging description	Carton box
		Packaging quantity	10 Pcs
		Packaging EAN code	8015747061780

Part number

PB 32002 PP



Catalogue drawings

(16 / 32A) PB ...PP

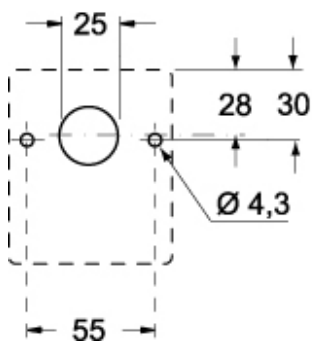
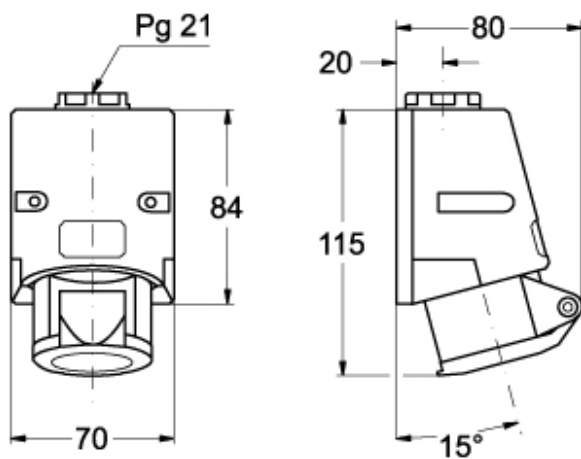

Notes