

Part number

MZV 15 LG20



Hood, IL-BRID series, with 1 lever, M20 top cable entry, size "49.16"

Product description

Product type	Hood
Series	IL-BRID
Closing type	With 1 lever
Size	Size 49.16
Cable entry	Top cable entry M20

Technical data

IP degree of protection	IP66 / IP67 / IP69
--------------------------------	--------------------

Further technical details

Weight	90,00 g
Operating temperature range (min, max)	-40°C...+125°C

Material properties

Other materials	Lever: Polyamide (PA) and Stainless steel core
Colour	RAL 7040 grey
RoHs conformity	Compliant
China RoHs - EFUP	E
REACH SVHC substances	No

Approvals / Standards

UL	ECBT2
cUL	ECBT8

General ordering information

EAN13 code	8015747168007
eCl@ss 8.1	27440202
ETIM 7.0	EC000437

Packaging Information

Sub-packaging weight	0,45 kg
Sub-packaging description	Plastic packaging
Sub-packaging quantity	5 Pcs
Sub-packaging EAN barcode	8015747168274

Part number

MZV 15 LG20



Catalogue drawings

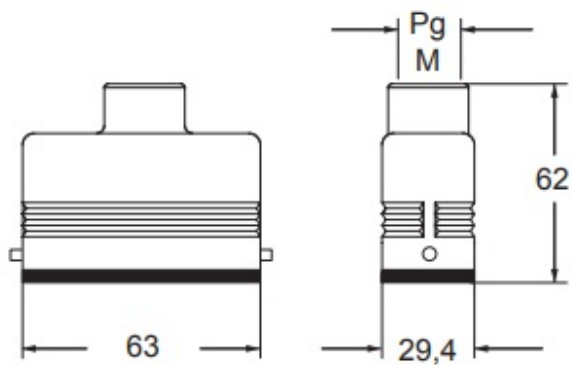

Notes