

Part number

MVAP 24LSP25



Surface mounting housing, V-TYPE series, with 1 lever, M25 cable entry, size "104.27", high construction, with SIMPLEX self-closing cover

Product description

Product type	Surface mounting housing
Series	V-TYPE
Closing type	With 1 lever
Size	Size 104.27
Cable entry	With cable entry M25
Specification	High construction, with SIMPLEX self-closing cover

Technical data

IP degree of protection	IP65
Further technical details	
Weight	1,00 g
Operating temperature range (min, max)	-40°C...+125°C

Material properties

Other materials	Lever: Stainless steel Gasket: NBR
Colour	RAL 7040 grey
RoHs conformity	Compliant
China RoHs - EFUP	E
REACH SVHC substances	No

Approvals / Standards

Certifications	DNV, BV
UL	ECBT2
cUL	ECBT8

General ordering information

EAN13 code	8015747267472
eCl@ss 8.1	27440202
ETIM 7.0	EC000437

Packaging Information

Packaging length	350,00 mm
Packaging height	160,00 mm
Packaging width	300,00 mm
Packaging volume	16,80 dm ³
Packaging description	Carton box
Packaging quantity	10 Pcs
Packaging EAN code	8015747283502
Sub-packaging description	Plastic packaging
Sub-packaging quantity	5 Pcs
Sub-packaging EAN barcode	8015747283519

Part number

MVAP 24LSP25



Catalogue drawings

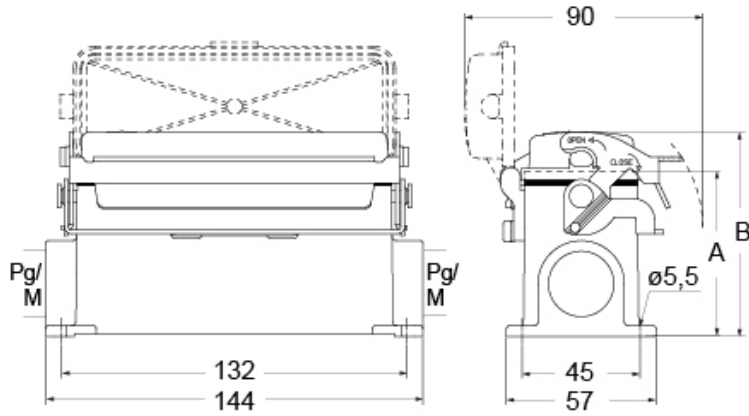

part No.	A	B
CVP / MVP 24 LSP	63	78
CVAP / MVAP 24 LSP	81	96

Notes