

Part number

MMAP 03.240

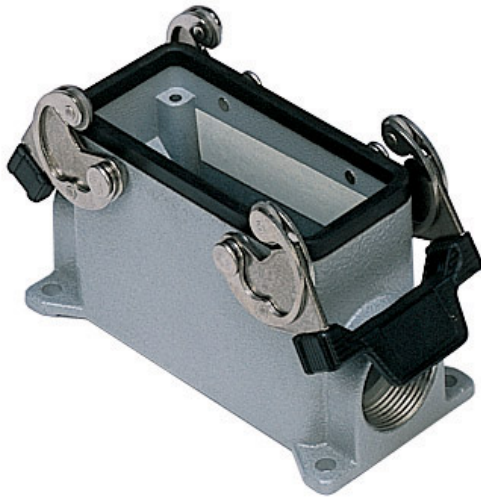

Surface mounting housing, 830V series, with 2 levers, M40 x 2 cable entry, size "57.27", high construction



Product description

Product type	Surface mounting housing
Series	830V
Closing type	With 2 levers
Size	Size 57.27
Cable entry	With cable entry M40 x 2
Specification	High construction

Technical data

IP degree of protection	IP65 / IP66 / IP69
--------------------------------	--------------------

Further technical details

Weight	315,00 g
Operating temperature range (min, max)	-40°C...+125°C

Material properties

Colour	RAL 7040 grey
RoHs conformity	Compliant
China RoHs - EFUP	E
REACH SVHC substances	No

Approvals / Standards

Certifications	DNV, BV
UL	ECBT2
cUL	ECBT8

General ordering information

EAN13 code	8015747057332
-------------------	---------------

Packaging Information

Sub-packaging weight	1,58 kg
Sub-packaging description	Plastic packaging
Sub-packaging quantity	5 Pcs
Sub-packaging EAN barcode	8015747057349

Part number

MMAP 03.240



Catalogue drawings

CMP CMAP - MMP MMAP

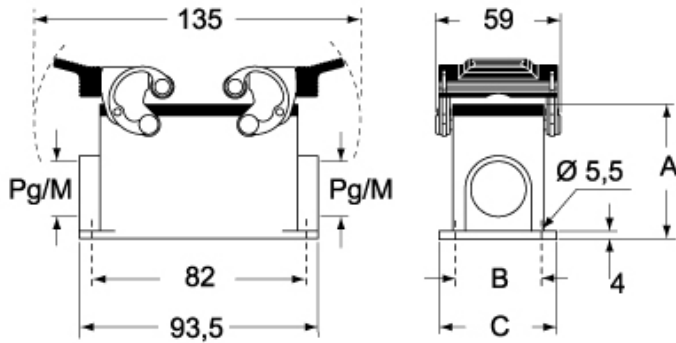

CMP CS/CP CMAP CS/CP - MMP CS/CP MMAP CS/CP

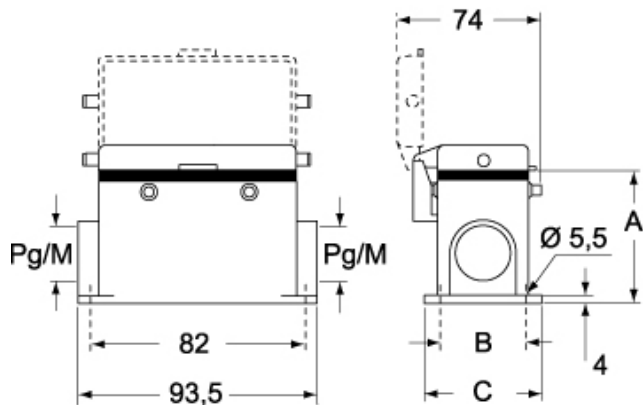

	A	B	C
CMP / MMP	57	40	52
CMAP / MMAP	73	45	57
CMP CS / MMP CS	57	40	52
CMAP CS / MMAP CS	73	45	57
CMP CP / MMP CP	57	40	52
CMAP CP / MMAP CP	73	45	57

Notes