

Part number

MMAO 03 L32



Hood, 830V series, with 2 pegs, M32 side cable entry, size "57.27", high construction

Product description

Product type	Hood
Series	830V
Closing type	With 2 pegs
Size	Size 57.27
Cable entry	Side cable entry M32
Specification	High construction

Technical data

IP degree of protection IP65 / IP66 / IP69

Further technical details

Weight	167,00 g
Operating temperature range (min, max)	-40°C...+125°C

Material properties

Colour	RAL 7040 grey
RoHs conformity	Compliant
China RoHs - EFUP	E
REACH SVHC substances	No

Approvals / Standards

Certifications	DNV, BV
UL	ECBT2
cUL	ECBT8

General ordering information

EAN13 code 8015747057028

Packaging Information

Sub-packaging weight	0,84 kg
Sub-packaging description	Plastic packaging
Sub-packaging quantity	5 Pcs
Sub-packaging EAN barcode	8015747106061

Part number

MMAO 03 L32



Catalogue drawings

CMO L (CMAO L) - MMO L [MMAO L]
CMV L [CMAV L] - MMV L (MMAV L)



CMV LG (CMAV LG) - MMV LG (MMAV LG)
[MMFV LG]

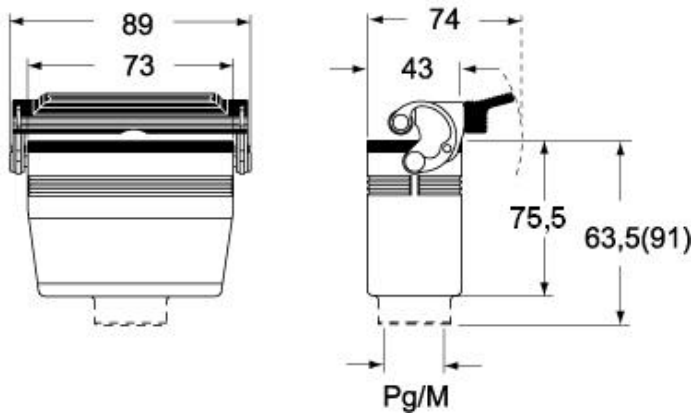

Notes