

Part number

MIO 16.50



Hood, C-TYPE series, with 4 pegs, M50 side cable entry, size "77.27", high construction, inclined

Product description

Product type	Hood
Series	C-TYPE
Closing type	With 4 pegs
Size	Size 77.27
Cable entry	Side cable entry M50
Specification	High construction, inclined

Technical data

IP degree of protection	IP65 / IP66 / IP69
--------------------------------	--------------------

Further technical details

Weight	255,60 g
Operating temperature range (min, max)	-40°C...+125°C

Material properties

Main material	Aluminium die-cast
Colour	RAL 7040 grey
RoHs conformity	Compliant
China RoHs - EFUP	E
REACH SVHC substances	No

Approvals / Standards

Certifications	DNV, BV
UL	ECBT2
cUL	ECBT8

General ordering information

EAN13 code	8015747152570
eCl@ss 8.1	27440202
ETIM 7.0	EC000437

Packaging Information

Sub-packaging weight	0,26 kg
Sub-packaging description	Plastic packaging
Sub-packaging quantity	1 Pcs
Sub-packaging EAN barcode	8015747161572

Part number

MIO 16.50



Catalogue drawings

CIO MIO

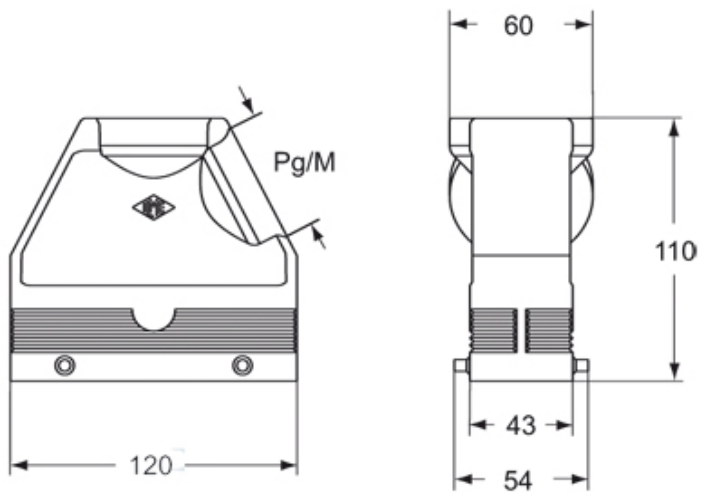

Notes