

Part number

MHV 16 X25

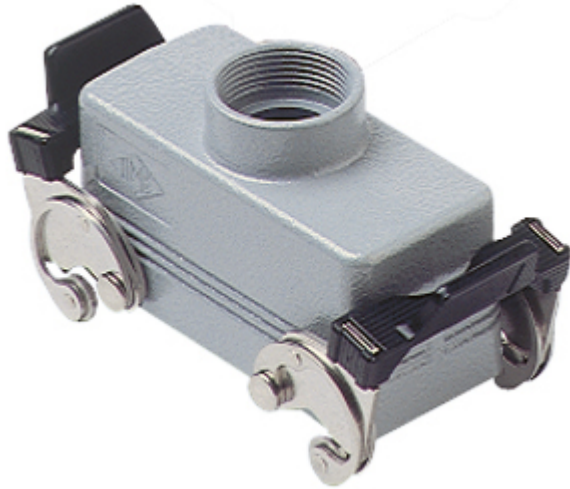

Hood, C-TYPE series, with 2 levers, M25 top cable entry, size "77.27", without gasket

Product description		Material properties	
Product type	Hood	Other materials	Lever: Stainless steel, polyamide (PA)
Series	C-TYPE	Colour	RAL 7040 grey
Closing type	With 2 levers	RoHs conformity	Compliant
Size	Size 77.27	China RoHs - EFUP	E
Cable entry	Top cable entry M25	REACH SVHC substances	No
Specification	Without gasket	Approvals / Standards	
Technical data		Certifications	DNV, BV
IP degree of protection	IP65 / IP66 / IP69	UL	ECBT2
Further technical details		cUL	ECBT8
Weight	212,00 g	General ordering information	
Operating temperature range (min, max)	-40°C...+125°C	EAN13 code	8015747055840
		eCl@ss 8.1	27440202
		ETIM 7.0	EC000437
		Packaging Information	
		Packaging length	300,00 mm
		Packaging height	160,00 mm
		Packaging width	180,00 mm
		Packaging weight	2,50 kg
		Packaging volume	8,64 dm ³
		Packaging description	Carton box
		Packaging quantity	10 Pcs
		Packaging EAN code	8015747055857
		Sub-packaging weight	1,25 kg
		Sub-packaging description	Plastic packaging
		Sub-packaging quantity	5 Pcs
		Sub-packaging EAN barcode	8015747055864

Part number

MHV 16 X25



Catalogue drawings

CHO X (CAO X) - MHO X (MAO X)

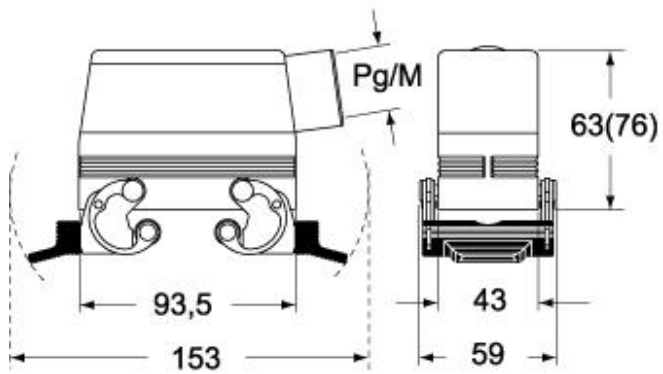

CHV X (CAV X) - MHV X (MAV X)

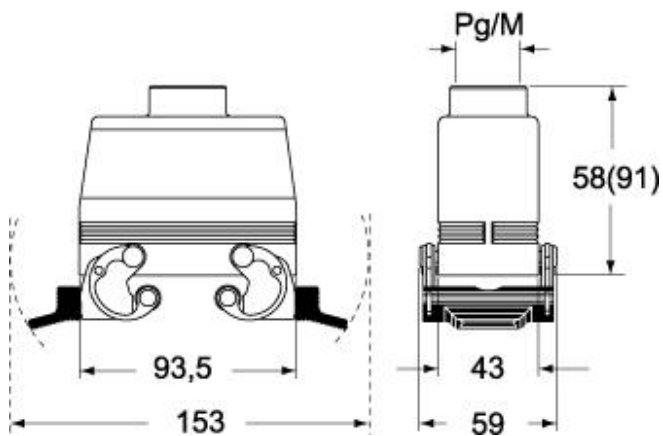

Notes