

Part number

# MGV 24.240



Hood, IP68 series, with 2 screws, M40 x 2 top cable entry, size "104.27"

Product description		Material properties	
<b>Product type</b>	Hood	<b>Main material</b>	Aluminium die-cast
<b>Series</b>	IP68	<b>Other materials</b>	Screws: Stainless steel
<b>Closing type</b>	With 2 screws	<b>Colour</b>	RAL 9005 black
<b>Size</b>	Size 104.27	<b>RoHs conformity</b>	Compliant
<b>Cable entry</b>	Top cable entry M40 x 2	<b>China RoHs - EFUP</b>	E
<b>Technical data</b>		<b>REACH SVHC substances</b>	No
<b>IP degree of protection</b>	IP66 / IP68 / IP69	<b>Approvals / Standards</b>	
<b>Further technical details</b>		<b>Certifications</b>	DNV, BV
<b>Weight</b>	527,50 g	<b>UL</b>	ECBT2
<b>Operating temperature range (min, max)</b>	-40°C...+125°C	<b>cUL</b>	ECBT8
		<b>General ordering information</b>	
		<b>EAN13 code</b>	8015747124102
		<b>eCl@ss 8.1</b>	27440202
		<b>ETIM 7.0</b>	EC000437
		<b>Packaging Information</b>	
		<b>Packaging length</b>	205,00 mm
		<b>Packaging height</b>	135,00 mm
		<b>Packaging width</b>	135,00 mm
		<b>Packaging weight</b>	1,17 kg
		<b>Packaging volume</b>	3,74 dm <sup>3</sup>
		<b>Packaging description</b>	Carton box
		<b>Packaging quantity</b>	2 Pcs
		<b>Packaging EAN code</b>	8015747124447
		<b>Sub-packaging weight</b>	0,59 kg
		<b>Sub-packaging description</b>	Plastic packaging
		<b>Sub-packaging quantity</b>	1 Pcs
		<b>Sub-packaging EAN barcode</b>	8015747124454

Part number

# MGV 24.240



Catalogue drawings

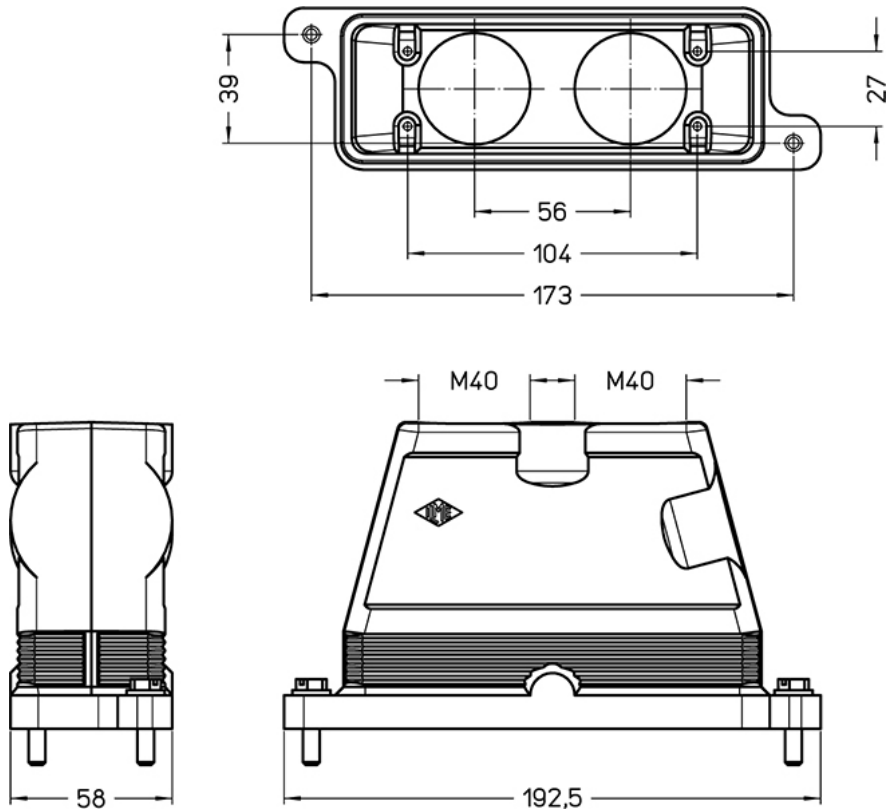

Notes