

Part number

MFV 32.40



Hood, C-TYPE series, with 4 pegs, M40 top cable entry without adapter, size "77.62"

Product description

Product type	Hood
Series	C-TYPE
Closing type	With 4 pegs
Size	Size 77.62
Cable entry	Top cable entry M40

Technical data

IP degree of protection	IP65 / IP66 / IP69
--------------------------------	--------------------

Further technical details

Weight	373,00 g
Operating temperature range (min, max)	-40°C...+125°C

Material properties

Colour	RAL 7040 grey
RoHs conformity	Compliant
China RoHs - EFUP	E
REACH SVHC substances	No

Approvals / Standards

Certifications	DNV, BV
UL	ECBT2
cUL	ECBT8

General ordering information

EAN13 code	8015747152280
eCl@ss 8.1	27440202
ETIM 7.0	EC000437

Packaging Information

Packaging length	255,00 mm
Packaging height	195,00 mm
Packaging width	245,00 mm
Packaging weight	3,22 kg
Packaging volume	12,18 dm ³
Packaging description	Carton box
Packaging quantity	8 Pcs
Packaging EAN code	8015747180047
Sub-packaging weight	0,40 kg
Sub-packaging description	Plastic packaging
Sub-packaging quantity	1 Pcs
Sub-packaging EAN barcode	8015747180054

Part number

MFV 32.40



Catalogue drawings

**CHO - CHV MHO/MFO/MFV - MHV
MMV (MMAV)**

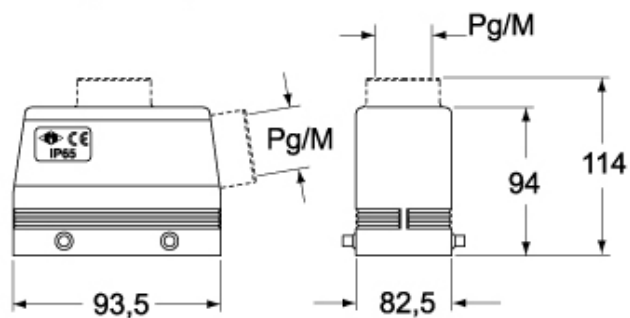

CHV G - MHV G - MFV G

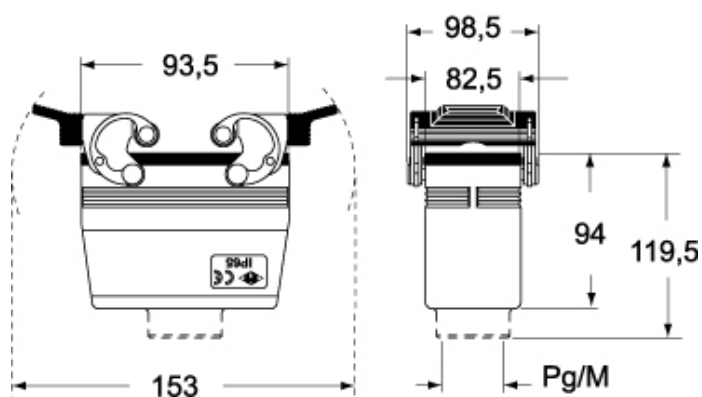

Notes