

Part number

MAV 16 LG32



Hood, C-TYPE series, with 1 lever, M32 top cable entry, size "77.27", high construction

Product description

Product type	Hood
Series	C-TYPE
Closing type	With 1 lever
Size	Size 77.27
Cable entry	Top cable entry with adapter M32
Specification	High construction

Technical data

IP degree of protection IP65 / IP66 / IP69

Further technical details

Weight	410,00 g
Operating temperature range (min, max)	-40°C...+125°C

Material properties

Other materials	Lever: Stainless steel, polyamide (PA) Gasket: NBR
Colour	RAL 7040 grey
RoHs conformity	Compliant with exemption 6(c): copper alloy containing up to 4% lead by weight
China RoHs - EFUP	50
REACH SVHC substances	Yes Lead
SCIP number	15deaf78-e939-4401-a0b0-e2228ca32a03

Approvals / Standards

Certifications	DNV, BV
UL	ECBT2
cUL	ECBT8

General ordering information

EAN13 code	8015747052504
eCl@ss 8.1	27440202
ETIM 7.0	EC000437

Packaging Information

Sub-packaging weight	2,05 kg
Sub-packaging description	Plastic packaging
Sub-packaging quantity	5 Pcs
Sub-packaging EAN barcode	8015747099912

Part number

MAV 16 LG32



Catalogue drawings

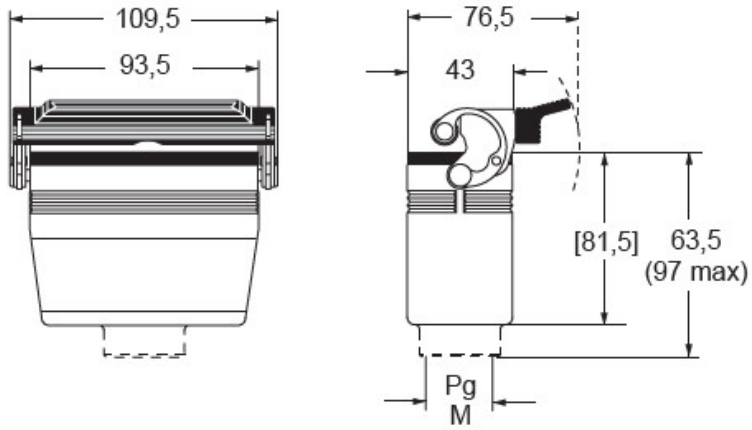

Notes