

Part number

JMPAP 16 L32



Surface mounting housing, JEl®-P series, with 1 lever, M32 cable entry, size 77.27, high construction

Product description		Material properties	
Product type	Surface mounting housing	Other materials	Lever: Polyamide (PA) Gasket: NBR
Series	JEl®-P	Colour	RAL 7040 grey
Closing type	With 1 lever	Approvals / Standards	
Size	Size 77.27	Certifications	DNV, BV
Cable entry	With cable entry M32	General ordering information	
Specification	High construction	EAN13 code	8015747303620
Technical data		Packaging Information	
IP degree of protection	IP65	Packaging length	475,00 mm
Further technical details		Packaging height	220,00 mm
Weight	1,00 g	Packaging width	175,00 mm
Operating temperature range (min, max)	-40°C...+125°C	Packaging volume	18,29 dm ³
		Packaging description	Carton box
		Packaging quantity	10 Pcs
		Packaging EAN code	8015747020657
		Sub-packaging description	Plastic packaging
		Sub-packaging quantity	5 Pcs
		Sub-packaging EAN barcode	8015747020664

Part number

JMPAP 16 L32



Catalogue drawings

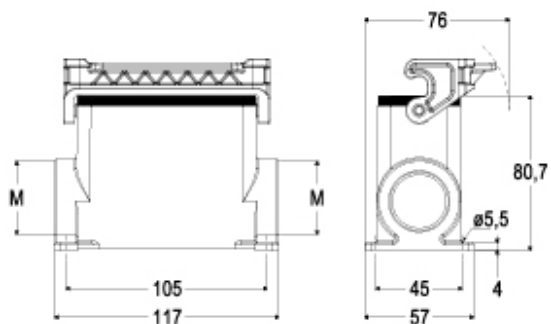

Notes