

Part number

JCVP 10 L



Surface mounting housing, JEI®-V series, with 1 lever, Pg16 cable entry, size "57.27"

Product description		Material properties	
Product type	Surface mounting housing	Other materials	Lever: Galvanized steel Gasket: NBR
Series	JEI®-V	Colour	RAL 7040 grey
Closing type	With 1 lever	Approvals / Standards	
Size	Size 57.27	Certifications	DNV, BV
Cable entry	With cable entry Pg16	UL	ECBT2
Technical data		cUL	ECBT8
IP degree of protection	IP65 / IP66 / IP69	General ordering information	
Further technical details		EAN13 code	8015747137669
Weight	241,00 g	Packaging Information	
Operating temperature range (min, max)	-40°C...+125°C	Packaging length	180,00 mm
		Packaging height	105,00 mm
		Packaging width	270,00 mm
		Packaging weight	4,92 kg
		Packaging volume	5,10 dm ³
		Packaging description	Carton box
		Packaging quantity	20 Pcs
		Packaging EAN code	8015747253512
		Sub-packaging weight	1,23 kg
		Sub-packaging description	Plastic packaging
		Sub-packaging quantity	5 Pcs
		Sub-packaging EAN barcode	8015747140294

Part number

JCVP 10 L



Catalogue drawings

JCVP L

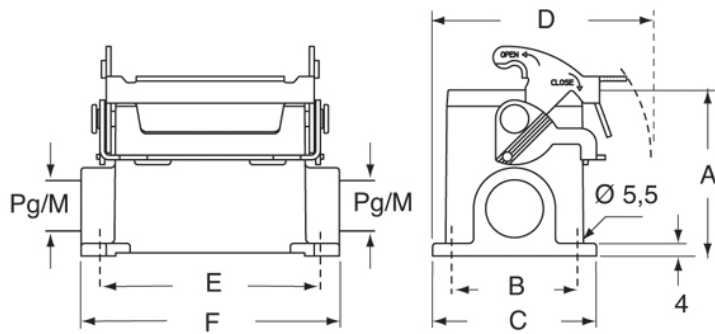

	A	B	C	D	E	F
JCVP 06 L	53	40	52	70	70	82
JCVP 10 L	57	40	52	73	82	93,5
JCVP 16 L	63	45	57	75,5	105	117
JCVP 24 L	63	45	57	75,5	132	144

Notes