

Part number

FM 4272 SQ



Box system for socket-outlet combinations, FM series, for socket outlets SQ series, 4 openings

Product description	
Product type	Box system for socket-outlet combinations
Series	FM
Size	320 x 510 x 135 mm
Specification	For socket outlets SQ series 4 openings
Technical data	
IP degree of protection	IP55
Further technical details	
Weight	4.000,00 g
Operating temperature range (min, max)	-40°C ... +125°C

Material properties	
Colour	RAL 7035 grey
General ordering information	
EAN13 code	8015747047784
Packaging Information	
Packaging length	430,00 mm
Packaging height	150,00 mm
Packaging width	730,00 mm
Packaging weight	4,80 kg
Packaging volume	47,09 dm ³
Packaging description	Carton box
Packaging quantity	1 Pcs
Packaging EAN code	8015747047791

Part number

FM 4272 SQ



Catalogue drawings

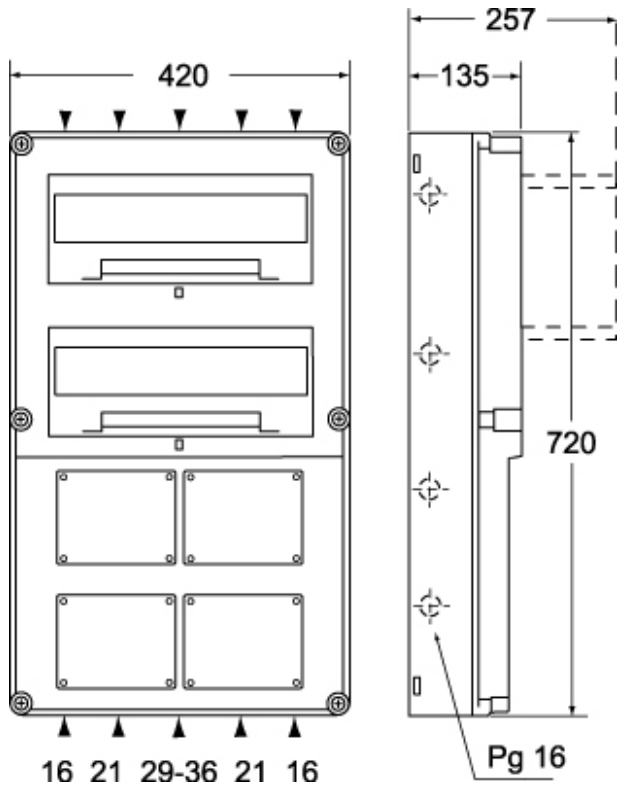

Catalogue drawings

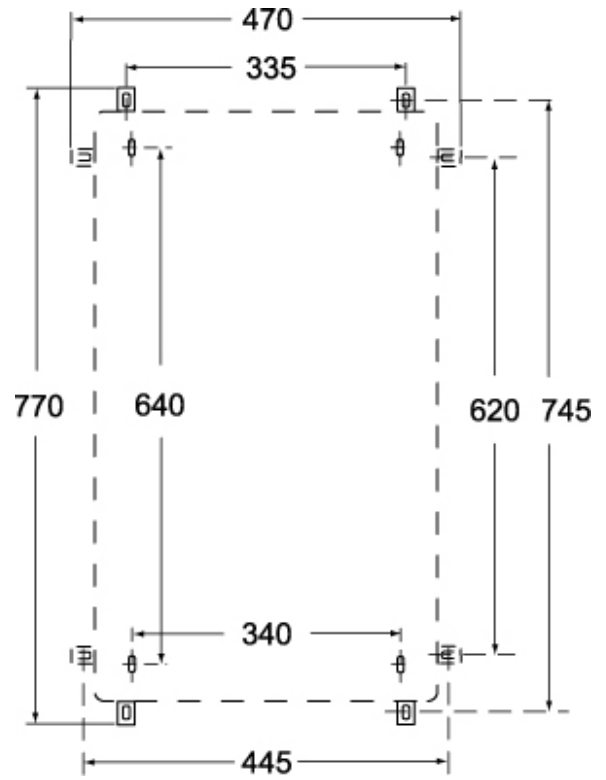

Notes