

Part number

CZP 15 LS2



Surface mounting housing, IL-BRID series, with 1 lever, Pg16 x 2 cable entry, size "49.16", with metal cover

Product description

Product type	Surface mounting housing
Series	IL-BRID
Closing type	With 1 lever
Size	Size 49.16
Cable entry	With cable entry Pg16 x 2
Specification	With metal cover

Technical data

IP degree of protection IP65 / IP66 / IP69

Further technical details

Weight	200,00 g
Operating temperature range (min, max)	-40°C...+125°C

Material properties

Other materials	Lever: Polyamide (PA) and Stainless steel core
Colour	RAL 7040 grey
RoHs conformity	Compliant
China RoHs - EFUP	E
REACH SVHC substances	No

Approvals / Standards

UL	ECBT2
cUL	ECBT8

General ordering information

EAN13 code 8015747044691

Packaging Information

Packaging length	190,00 mm
Packaging height	125,00 mm
Packaging width	330,00 mm
Packaging weight	2,24 kg
Packaging volume	7,84 dm ³
Packaging description	Carton box
Packaging quantity	10 Pcs
Packaging EAN code	8015747220392
Sub-packaging weight	1,12 kg
Sub-packaging description	Plastic packaging
Sub-packaging quantity	5 Pcs
Sub-packaging EAN barcode	8015747220408

Part number

CZP 15 LS2



Catalogue drawings

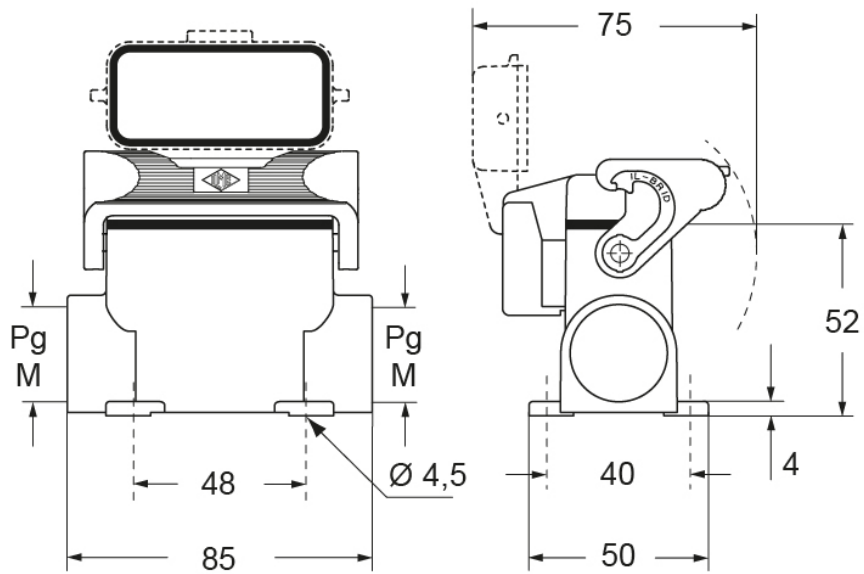

Notes