

Part number

CZFO 25 L16



Hood, IL-BRID series, with 2 pegs, Pg16 side cable entry without adapter, size "66.16", high construction

Product description		Material properties	
Product type	Hood	Other materials	Gasket: NBR
Series	IL-BRID	Colour	RAL 7040 grey
Closing type	With 2 pegs	RoHs conformity	Compliant
Size	Size 66.16	China RoHs - EFUP	E
Cable entry	Side cable entry Pg16	REACH SVHC substances	No
Specification	High construction	Approvals / Standards	
Technical data		UL	ECBT2
IP degree of protection	IP66 / IP67 / IP69	cUL	ECBT8
Further technical details		General ordering information	
Weight	151,50 g	EAN13 code	8015747150514
Operating temperature range (min, max)	-40°C...+125°C	Packaging Information	
		Packaging length	225,00 mm
		Packaging height	130,00 mm
		Packaging width	150,00 mm
		Packaging weight	1,60 kg
		Packaging volume	4,39 dm ³
		Packaging description	Carton box
		Packaging quantity	10 Pcs
		Packaging EAN code	8015747060318
		Sub-packaging weight	0,80 kg
		Sub-packaging description	Plastic packaging
		Sub-packaging quantity	5 Pcs
		Sub-packaging EAN barcode	8015747060332

Part number

CZFO 25 L16



Catalogue drawings

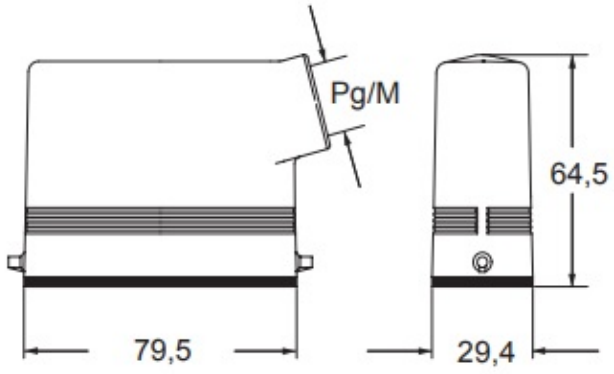

Notes