

Part number

CX 4.0 VC



Female pneumatic contact, with closing valve,
for tubes with internal diameter 4 mm

Product description	
Product type	Pneumatic contact
Gender	Female
Specification	With closing valve For tubes with internal diameter 4 mm
Further technical details	
Weight	0,59 g
Operating temperature range (min, max)	-40°C ... +125°C

Material properties	
Main material	Polyamide (PA)
RoHS conformity	Compliant
China RoHS - EFUP	E
REACH SVHC substances	No
General ordering information	
EAN13 code	8015747042185
eCl@ss 8.1	27440204
ETIM 7.0	EC000796
Packaging Information	
Sub-packaging description	Plastic bag
Sub-packaging quantity	3 Pcs
Sub-packaging EAN barcode	8015747042192

Part number

CX 4.0 VC



Catalogue drawings

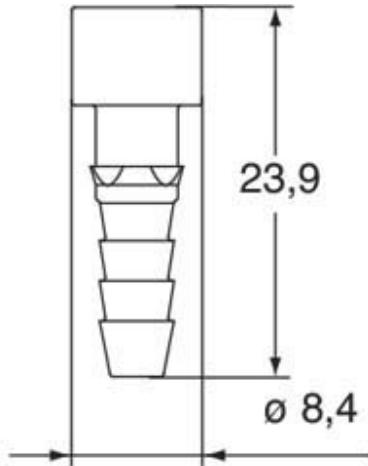

Notes