

Part number

CWKA 2 J2M8



Male RJ45 connector, CWK patch cords series, size "21.21", in metal enclosure, 2 m cable



Product description		Material properties	
Product type	Data connector	Colour	RAL 7040 grey
Series	CWK patch cords		Compliant with exemption 6(c): copper alloy containing up to 4% lead by weight
Connection type	RJ45	RoHs conformity	
Gender	Male	China RoHs - EFUP	50
Size	Size "21.21"	REACH SVHC substances	Yes Lead
Specification	In metal enclosure 2 m cable	SCIP number	8b60cf05-8f5f-42af-80f1-e79cea373159
Technical data		General ordering information	
IP degree of protection	IP66 / IP67	EAN13 code	8015747166935
Further technical details		eCl@ss 8.1	27060308
Operating temperature range (min, max)	-40°C ... +120°C	ETIM 7.0	EC002599
		Packaging Information	
		Sub-packaging description	Plastic bag
		Sub-packaging quantity	1 Pcs
		Sub-packaging EAN barcode	8015747084628

Part number

CWKA 2 J2M8



Catalogue drawings

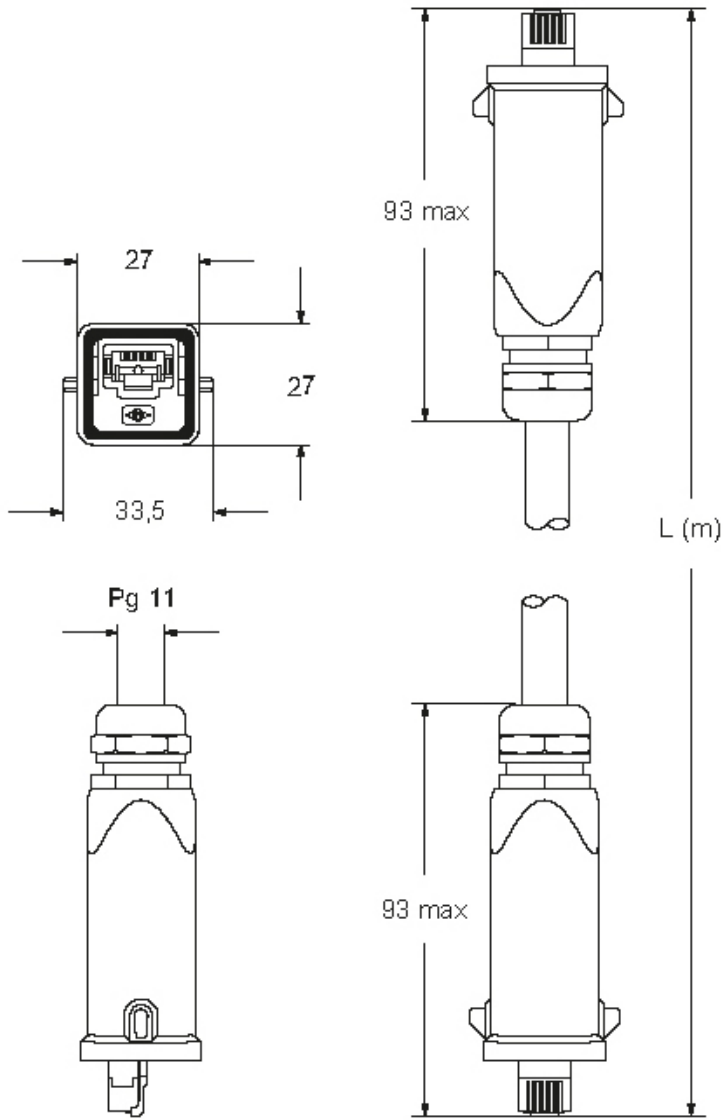

Notes