

Part number
CSSM 06



Male insert, CSS series, dual spring terminal connection, 6 poles + PE, 16 A 500 V 6 kV 3, size "44.27"

Product description		Material properties	
Product type	Insert	Main material	Polycarbonate (PC)
Series	CSS	Other materials	Contacts: copper alloy
Connection type	Dual spring terminal connection	Colour	RAL 7032 grey
Gender	Male	RoHs conformity	Compliant with exemption 6(c): copper alloy containing up to 4% lead by weight
N. of poles	6 poles +	China RoHs - EFUP	50
Size	Size 44.27	REACH SVHC substances	Yes Lead
Technical data		SCIP number	1a9c93ff-0445-4a16-81e3-1609ac5274d6
Current	16 A	Approvals / Standards	
Voltage	500 V	Reference standard	EN 61984:2009-06
Rated impulse withstand voltage	6 kV	Certifications	CSA, CQC, DNV, BV, EAC
Pollution degree	3	UL	ECBT2
Rated voltage according to UL/CSA	600 V	General ordering information	
Wire cross-section	0,14 mm ² - 2,50 mm ²	EAN13 code	8015747115797
AWG size	26 - 14	eCl@ss 8.1	27440205
Contact type	Turned silver plated	ETIM 7.0	EC000438
IP degree of protection	IP20 without enclosure, IP65/IP66/IP68/IP69 with enclosure	Packaging Information	
Further technical details		Packaging length	240,00 mm
Characteristics according to EN 61984	16A 500V 6kV 3; 16A 400/690V 6kV 2	Packaging height	220,00 mm
Mating cycles	≥ 500	Packaging width	210,00 mm
Insulation resistance	≥ 10 GΩ	Packaging weight	4,02 kg
Contact resistance	≤ 3 mΩ	Packaging volume	11,09 dm ³
Weight	61,70 g	Packaging description	Carton box
Operating temperature range (min, max)	-40 °C ... +125 °C	Packaging quantity	60 Pcs
Conductors stripping length	9...11 mm	Packaging EAN code	8015747215671
UL 94 flammability rating	V-0	Sub-packaging length	197,00 mm
		Sub-packaging height	44,00 mm
		Sub-packaging width	113,00 mm
		Sub-packaging weight	0,67 kg
		Sub-packaging volume	0,98 dm ³
		Sub-packaging description	Carton tray
		Sub-packaging quantity	10 Pcs
		Sub-packaging EAN barcode	8015747115865

Part number

CSSM 06



Catalogue drawings

Catalogue drawings

CSSF / CSSM 06

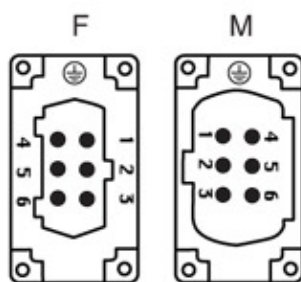
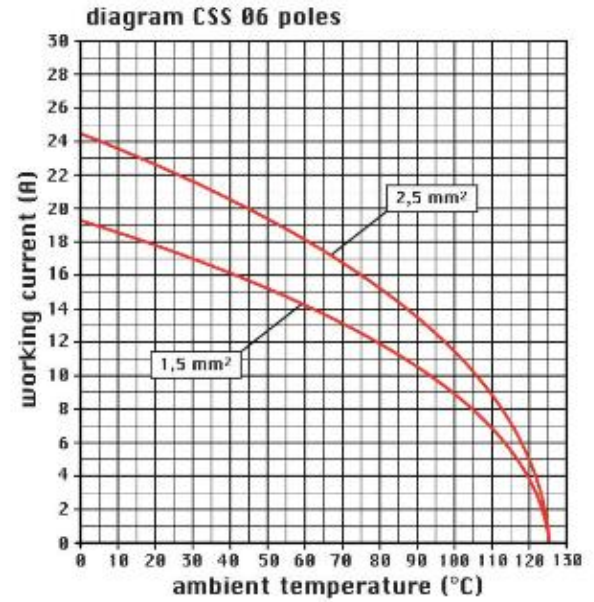
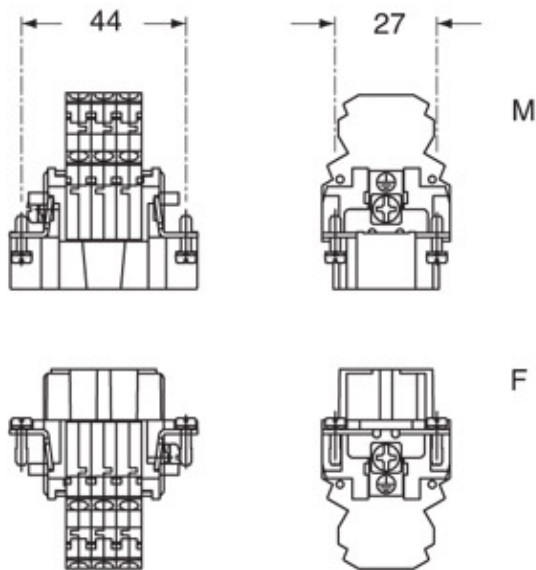

Notes

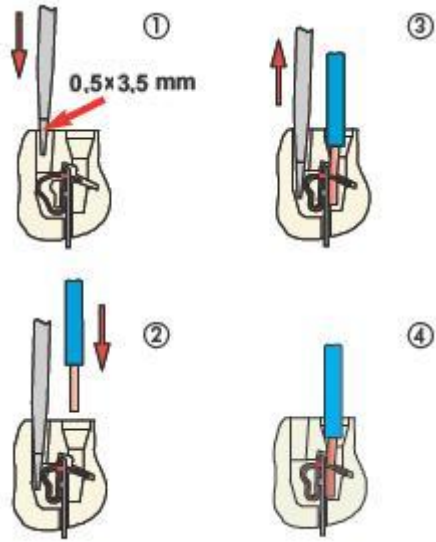

California Proposition 65 Information



WARNING

This product can expose you to lead and its compounds, known to the State of California to cause cancer and/or reproductive toxicity. For more information go to www.P65Warnings.ca.gov.