

Part number

CSSF 10



Female insert, CSS series, dual spring terminal connection, 10 poles + PE, 16 A 500 V 6 kV 3, size "57.27"

Product description		Material properties	
Product type	Insert	Main material	Polycarbonate (PC)
Series	CSS	Other materials	Contacts: copper alloy
Connection type	Dual spring terminal connection	Colour	RAL 7032 grey
Gender	Female		Compliant with exemption 6(c): copper alloy containing up to 4% lead by weight
N. of poles	10 poles +	RoHs conformity	
Size	Size 57.27	China RoHs - EFUP	50
Technical data		REACH SVHC substances	Yes Lead
Current	16 A	SCIP number	1a9c93ff-0445-4a16-81e3-1609ac5274d6
Voltage	500 V	Approvals / Standards	
Rated impulse withstand voltage	6 kV	Reference standard	EN 61984:2009-06
Pollution degree	3	Certifications	CSA, CQC, DNV, BV, EAC
Rated voltage according to UL/CSA	600 V	UL	ECBT2
Wire cross-section	0,14 mm ² - 2,50 mm ²	General ordering information	
AWG size	26 - 14	EAN13 code	8015747115711
Contact type	Turned silver plated	eCl@ss 8.1	27440205
IP degree of protection	IP20 without enclosure, IP65/IP66/IP68/IP69 with enclosure	ETIM 7.0	EC000438
Further technical details		Packaging Information	
Characteristics according to EN 61984	16A 500V 6kV 3; 16A 400/690V 6kV 2	Packaging length	240,00 mm
Mating cycles	≥ 500	Packaging height	220,00 mm
Insulation resistance	≥ 10 GΩ	Packaging width	210,00 mm
Contact resistance	≤ 3 mΩ	Packaging weight	3,09 kg
Weight	87,70 g	Packaging volume	11,09 dm ³
Operating temperature range (min, max)	-40 °C ... +125 °C	Packaging description	Carton box
Conductors stripping length	9...11 mm	Packaging quantity	30 Pcs
UL 94 flammability rating	V-0	Packaging EAN code	8015747215626
		Sub-packaging length	197,00 mm
		Sub-packaging height	44,00 mm
		Sub-packaging width	113,00 mm
		Sub-packaging weight	0,52 kg
		Sub-packaging volume	0,98 dm ³
		Sub-packaging description	Carton tray
		Sub-packaging quantity	5 Pcs
		Sub-packaging EAN barcode	8015747115766

Part number

CSSF 10



Catalogue drawings

Catalogue drawings

CSSF / CSSM 10

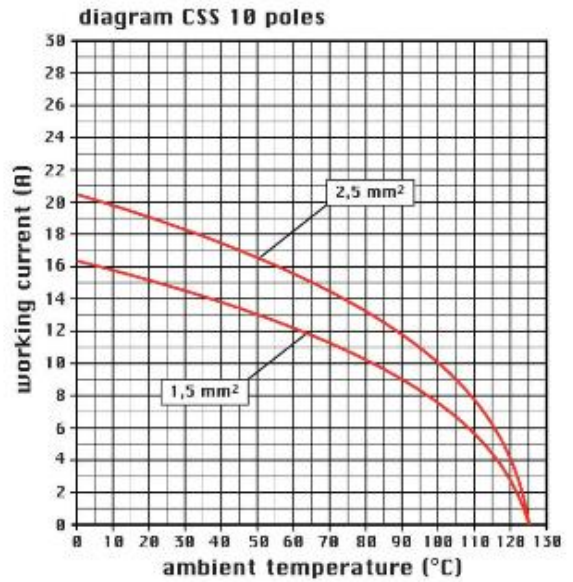
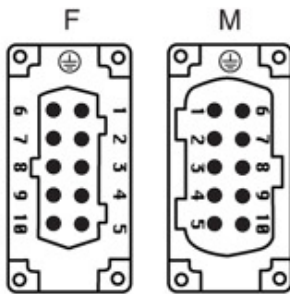
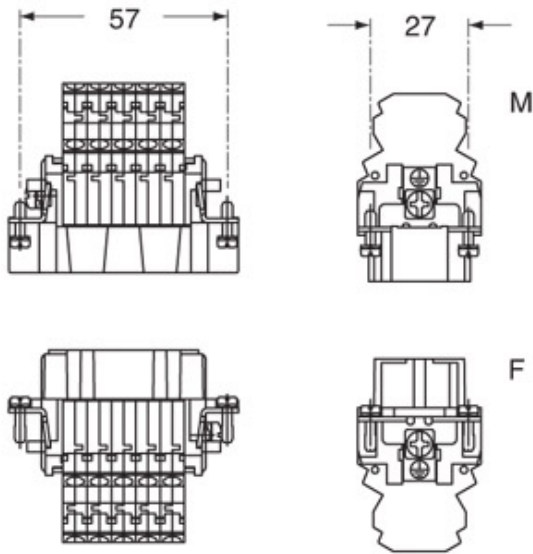

Notes



California Proposition 65 Information



WARNING

This product can expose you to lead and its compounds, known to the State of California to cause cancer and/or reproductive toxicity. For more information go to www.P65Warnings.ca.gov.
