

Part number

CSHM 06



Male insert, CSH series, SQUICH® spring terminal connection without tools, 6 poles + PE, 16 A 500 V 6 kV 3, size "44.27"

Product description		Material properties	
Product type	Insert	Main material	Polycarbonate (PC)
Series	CSH	Other materials	Contacts: copper alloy
Connection type	SQUICH® spring terminal connection without tools	Colour	RAL 7032 grey
Gender	Male	RoHs conformity	Compliant with exemption 6(c): copper alloy containing up to 4% lead by weight
N. of poles	6 poles + 	China RoHs - EFUP	50
Size	Size 44.27	REACH SVHC substances	Yes Lead
Technical data		SCIP number	1a9c93ff-0445-4a16-81e3-1609ac5274d6
Current	16 A	Approvals / Standards	
Voltage	500 V	Reference standard	EN 61984:2009-06
Rated impulse withstand voltage	6 kV	Certifications	CSA, CQC, DNV, BV, EAC
Pollution degree	3	UL	ECBT2, PVVA2
Rated voltage according to UL/CSA	600 V	cUL	ECBT8, PVVA8
Wire cross-section	0,14 mm ² - 2,50 mm ²	General ordering information	
AWG size	26 - 14	EAN13 code	8015747053990
Contact type	Turned silver plated	eCl@ss 8.1	27440205
IP degree of protection	IP20 without enclosure, IP65/IP66/IP68/IP69 with enclosure	ETIM 7.0	EC000438
Further technical details		Packaging Information	
Characteristics according to EN 61984	16A 500V 6kV 3; 16A 400/690V 6kV 2	Packaging length	245,00 mm
Mating cycles	≥ 500	Packaging height	165,00 mm
Insulation resistance	≥ 10 GΩ	Packaging width	215,00 mm
Contact resistance	≤ 3 mΩ	Packaging weight	3,52 kg
Weight	57,00 g	Packaging volume	8,69 dm ³
Operating temperature range (min, max)	-40 °C ... +125 °C	Packaging description	Carton box
Conductors stripping length	9...11 mm	Packaging quantity	60 Pcs
UL 94 flammability rating	V-0	Packaging EAN code	8015747170727
		Sub-packaging length	197,00 mm
		Sub-packaging height	44,00 mm
		Sub-packaging width	113,00 mm
		Sub-packaging weight	0,59 kg
		Sub-packaging volume	0,98 dm ³
		Sub-packaging description	Carton tray
		Sub-packaging quantity	10 Pcs
		Sub-packaging EAN barcode	8015747170734

Part number

CSHM 06



Catalogue drawings

Catalogue drawings

dimensions in mm

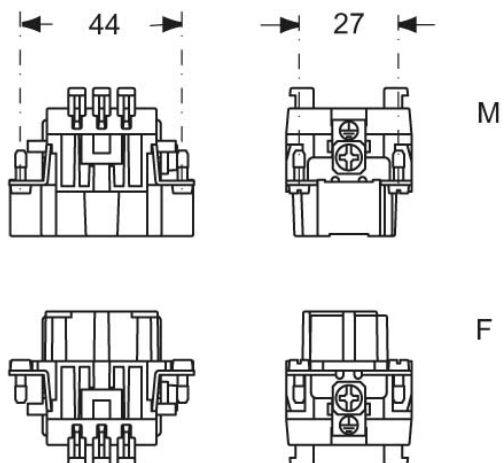

contacts side (front view)

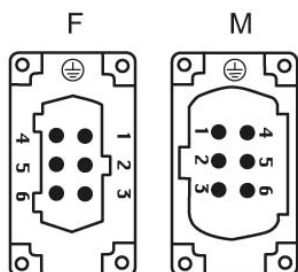
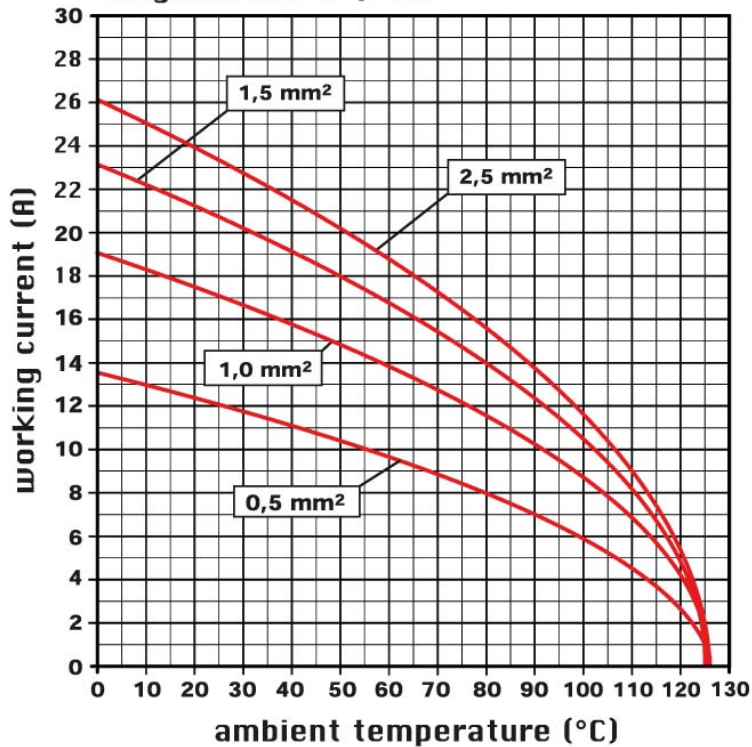

diagram CSH 06 poles



Notes

California Proposition 65 Information



WARNING

This product can expose you to lead and its compounds, known to the State of California to cause cancer and/or reproductive toxicity. For more information go to www.P65Warnings.ca.gov.

California Proposition 65 Information



WARNING

This product can expose you to lead and its compounds, known to the State of California to cause cancer and/or reproductive toxicity. For more information go to www.P65Warnings.ca.gov.

