

Part number

CR 37 AD1

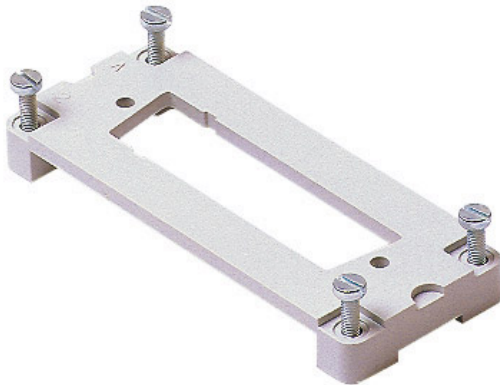

Adapter plate, size "77.27", for one 37 poles D-SUB insert

Product description

Product type	Adapter plate
Size	Size 77.27
Specification	For one 37 poles D-SUB insert

Further technical details

Weight	8,50 g
---------------	--------

General ordering information

EAN13 code	8015747037808
eCl@ss 8.1	27440201
ETIM 7.0	EC002309

Packaging Information

Sub-packaging weight	0,09 kg
Sub-packaging description	Carton box
Sub-packaging quantity	10 Pcs
Sub-packaging EAN barcode	8015747037815

Part number

CR 37 AD1



Catalogue drawings

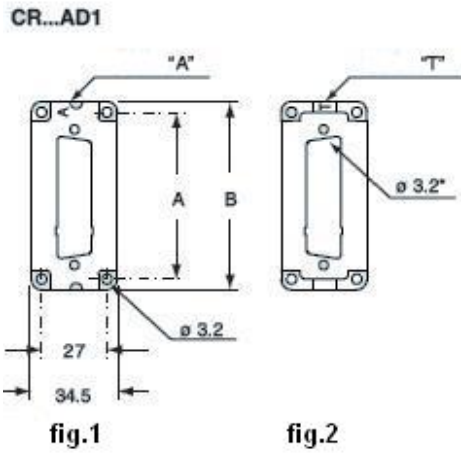

Notes