

Part number

CMAP 06.29



Surface mounting housing, 830V series, with 2 levers, Pg29 cable entry, size "77.27", high construction



Product description

Product type	Surface mounting housing
Series	830V
Closing type	With 2 levers
Size	Size 77.27
Cable entry	With cable entry Pg29
Specification	High construction

Technical data

IP degree of protection	IP65 / IP66 / IP69
--------------------------------	--------------------

Further technical details

Weight	411,00 g
Operating temperature range (min, max)	-40°C...+125°C

Material properties

Colour	RAL 7040 grey
RoHs conformity	Compliant
China RoHs - EFUP	E
REACH SVHC substances	No

Approvals / Standards

Certifications	DNV, BV
UL	ECBT2
cUL	ECBT8

General ordering information

EAN13 code	8015747029360
-------------------	---------------

Packaging Information

Sub-packaging weight	2,06 kg
Sub-packaging description	Plastic packaging
Sub-packaging quantity	5 Pcs
Sub-packaging EAN barcode	8015747029377

Part number

CMAP 06.29



Catalogue drawings

CMP CMAP - MMP MMAP



CMP CS/CP CMAP CS/CP - MMP CS/CP MMAP CS/CP

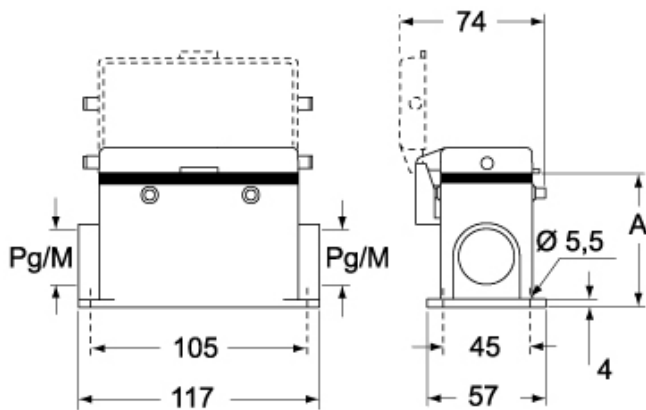

	A
CMP / MMP	63
CMAP / MMAP	77
CMP CS / MMP CS	63
CMAP CS / MMAP CS	77
CMP CP / MMP CP	63
CMAP CP / MMAP CP	77

Notes