

Part number

CHV 32 G42



Hood, C-TYPE series, with 2 levers, Pg42 top cable entry, size "77.62"

Product description

Product type	Hood
Series	C-TYPE
Closing type	With 2 levers
Size	Size 77.62
Cable entry	Top cable entry with adapter Pg42

Technical data

IP degree of protection IP65 / IP66 / IP69

Further technical details

Weight	561,78 g
Operating temperature range (min, max)	-40°C...+125°C

Material properties

Other materials	Lever: Stainless steel, polyamide (PA) Gasket: NBR
Colour	RAL 7040 grey
RoHs conformity	Compliant with exemption 6(c): copper alloy containing up to 4% lead by weight
China RoHs - EFUP	50
REACH SVHC substances	Yes Lead
SCIP number	15deaf78-e939-4401-a0b0-e2228ca32a03
Approvals / Standards	
Certifications	DNV, BV
UL	ECBT2
cUL	ECBT8

General ordering information

EAN13 code 8015747024952

Packaging Information

Sub-packaging weight	0,56 kg
Sub-packaging description	Plastic packaging
Sub-packaging quantity	1 Pcs
Sub-packaging EAN barcode	8015747024969

Part number

CHV 32 G42



Catalogue drawings

**CHO - CHV MHO/MFO/MFV - MHV
MMV (MMAV)**



CHV G - MHV G - MFV G

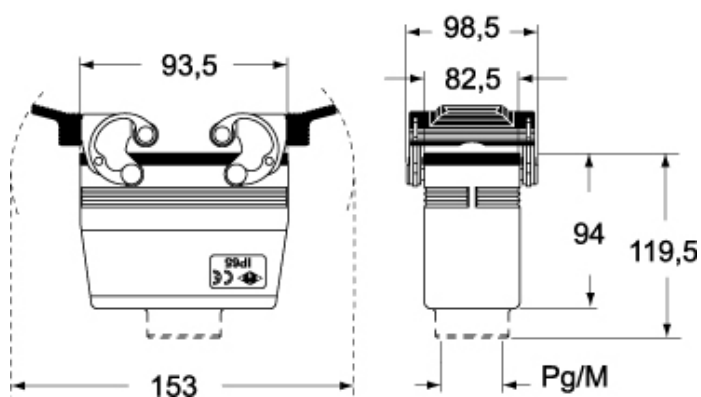

Notes