

Part number

CHPX 50.29



Surface mounting housing, C-TYPE series, with 2 levers, Pg29 cable entry, size "66.40"

Product description

Product type	Surface mounting housing
Series	C-TYPE
Closing type	With 2 levers
Size	Size "66.40"
Cable entry	With cable entry Pg29

Technical data

IP degree of protection IP66 / IP69

Further technical details

Operating temperature range (min, max) -40°C...+125°C

Material properties

Other materials	Lever: Stainless steel Gasket: NBR
Colour	RAL 7040 grey
RoHs conformity	Compliant
China RoHs - EFUP	E
REACH SVHC substances	No

Approvals / Standards

Certifications	DNV, BV
UL	ECBT2
cUL	ECBT8

General ordering information

EAN13 code 8015747276320

Part number

CHPX 50.29



Catalogue drawings

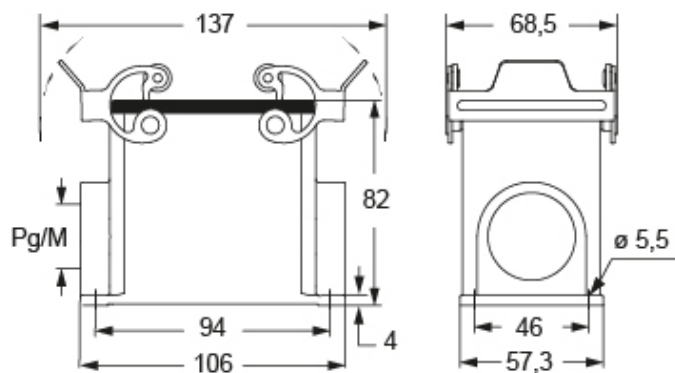

Notes