

Part number

CHP 50 CS2



Surface mounting housing, C-TYPE series, with 4 pegs, Pg21 x 2 cable entry, size "66.40", with metal cover

Product description		Material properties	
Product type	Surface mounting housing	Other materials	Gasket: NBR
Series	C-TYPE	Colour	RAL 7040 grey
Closing type	With 4 pegs	RoHs conformity	Compliant
Size	Size "66.40"	China RoHs - EFUP	E
Cable entry	With cable entry Pg21 x 2	REACH SVHC substances	No
Specification	With metal cover	Approvals / Standards	
Technical data		Certifications	DNV, BV
IP degree of protection	IP65	UL	ECBT2
Further technical details		cUL	ECBT8
Weight	467,00 g	General ordering information	
Operating temperature range (min, max)	-40°C...+125°C	EAN13 code	8015747023177
		Packaging Information	
		Sub-packaging length	175,00 mm
		Sub-packaging height	100,00 mm
		Sub-packaging width	235,00 mm
		Sub-packaging weight	2,34 kg
		Sub-packaging volume	4,11 dm ³
		Sub-packaging description	Carton box
		Sub-packaging quantity	5 Pcs
		Sub-packaging EAN barcode	8015747023184

Part number

CHP 50 CS2



Catalogue drawings

CHP - MHP



CHP CS - MHP CS

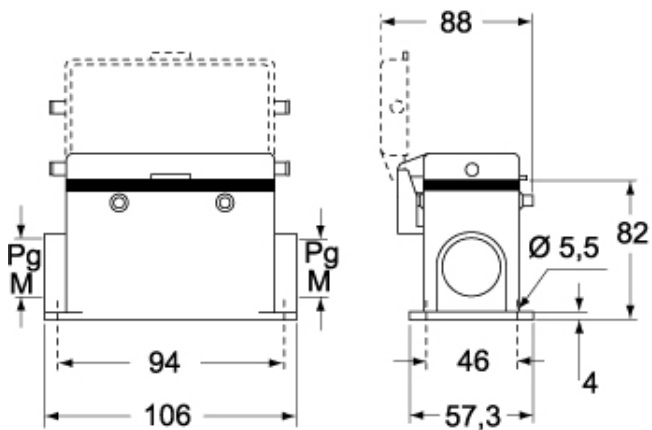

Catalogue drawings



Notes