

Part number
CHI 32 L

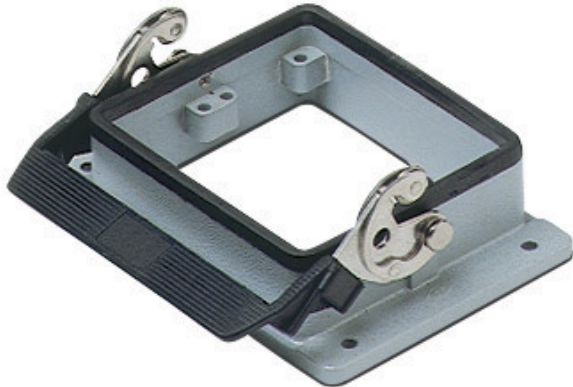

Bulkhead mounting housing, C-TYPE series, with 1 lever, size "77.62"



Product description

Product type	Bulkhead mounting housing
Series	C-TYPE
Closing type	With 1 lever
Size	Size 77.62
Cable entry	Without cable entry

Technical data

IP degree of protection	IP65 / IP66 / IP69
--------------------------------	--------------------

Further technical details

Weight	220,00 g
Operating temperature range (min, max)	-40°C...+125°C

Material properties

Other materials	Lever: Stainless steel, polyamide (PA) Gasket: NBR
Colour	RAL 7040 grey
RoHs conformity	Compliant
China RoHs - EFUP	E
REACH SVHC substances	No

Approvals / Standards

Certifications	DNV, BV
UL	ECBT2
cUL	ECBT8

General ordering information

EAN13 code	8015747018579
eCl@ss 8.1	27440202
ETIM 7.0	EC000437

Packaging Information

Packaging length	225,00 mm
Packaging height	130,00 mm
Packaging width	150,00 mm
Packaging weight	1,00 kg
Packaging volume	4,39 dm ³
Packaging description	Carton box
Packaging quantity	4 Pcs
Packaging EAN code	8015747210430
Sub-packaging weight	0,25 kg
Sub-packaging description	Plastic packaging
Sub-packaging quantity	1 Pcs
Sub-packaging EAN barcode	8015747210447

Part number

CHI 32 L



Catalogue drawings

CHI L

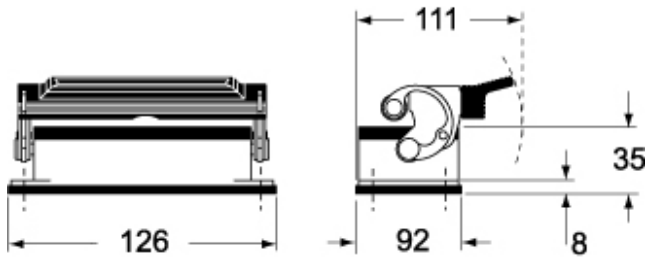

CHI LS

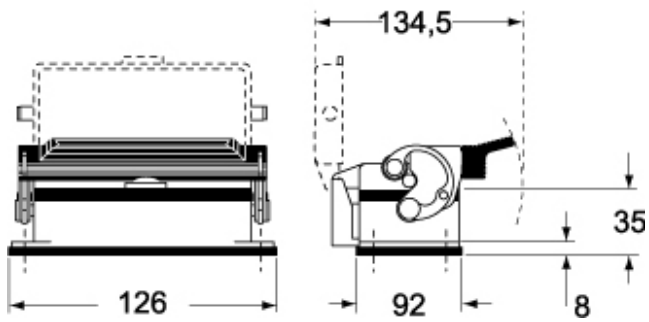

Catalogue drawings

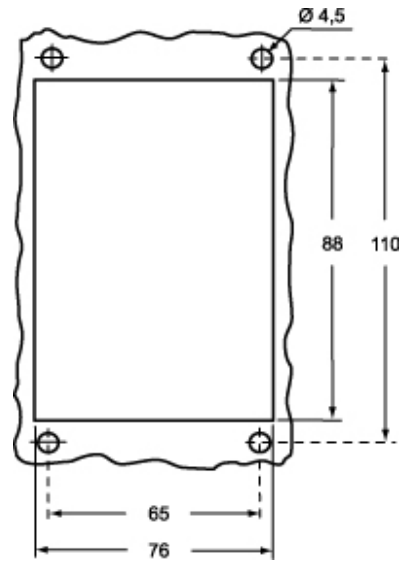

Notes