

Part number

CGP 10.29



Surface mounting housing, IP68 series, for 2 screws, Pg29 cable entry, size "57.27"

Product description		Material properties	
Product type	Surface mounting housing	Main material	Aluminium die-cast
Series	IP68	Other materials	Gasket: NBR
Closing type	With 2 screws	Colour	RAL 9005 black
Size	Size 57.27	RoHs conformity	Compliant
Cable entry	With cable entry Pg29	China RoHs - EFUP	E
Technical data		REACH SVHC substances	No
IP degree of protection	IP66 / IP68 / IP69	Approvals / Standards	
Further technical details		Certifications	DNV, BV
Weight	809,00 g	UL	ECBT2
Operating temperature range (min, max)	-40°C...+125°C	cUL	ECBT8
		General ordering information	
		EAN13 code	8015747141406
		Packaging Information	
		Packaging length	180,00 mm
		Packaging height	120,00 mm
		Packaging width	155,00 mm
		Packaging weight	1,72 kg
		Packaging volume	3,35 dm ³
		Packaging description	Carton box
		Packaging quantity	2 Pcs
		Packaging EAN code	8015747141734
		Sub-packaging weight	0,86 kg
		Sub-packaging description	Plastic packaging
		Sub-packaging quantity	1 Pcs
		Sub-packaging EAN barcode	8015747141741

Part number

CGP 10.29



Catalogue drawings

CGP - MGP

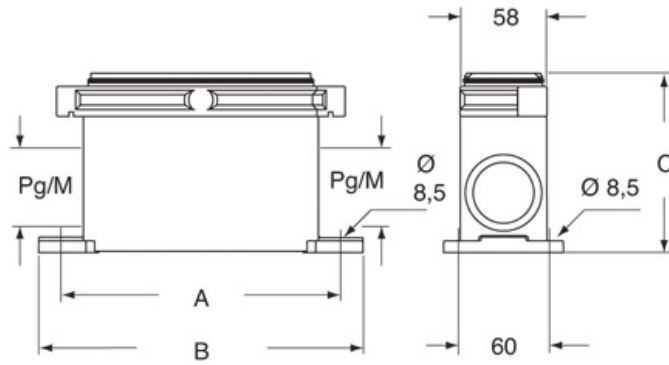

	A	B	C
CGP 06 - MGP 06	127	156	110
CGP 10 - MGP 10	140	169	110
CGP 16 - MGP 16	160	189	121
CGP 24 - MGP 24	187	216	121

Notes