

Part number

# CGC 24 G



Cover, IP68 series, with 2 screws, size "104.27", for hoods



Product description		Material properties	
<b>Product type</b>	Cover	<b>Main material</b>	Aluminium die-cast
<b>Series</b>	IP68	<b>Other materials</b>	Screws: Stainless steel
<b>Closing type</b>	With 2 screws	<b>Colour</b>	RAL 9005 black
<b>Size</b>	Size 104.27	<b>RoHs conformity</b>	Compliant
<b>Cable entry</b>	For hoods	<b>China RoHs - EFUP</b>	E
Technical data		<b>REACH SVHC substances</b>	No
<b>IP degree of protection</b>	IP66 / IP68 / IP69	General ordering information	
Further technical details		<b>EAN13 code</b>	8015747292689
<b>Weight</b>	181,43 g	<b>eCl@ss 8.1</b>	27440208
<b>Operating temperature range (min, max)</b>	-40°C...+125°C	<b>ETIM 7.0</b>	EC002314
		Packaging Information	
		<b>Sub-packaging length</b>	195,00 mm
		<b>Sub-packaging height</b>	40,00 mm
		<b>Sub-packaging width</b>	60,00 mm
		<b>Sub-packaging weight</b>	0,18 kg
		<b>Sub-packaging volume</b>	0,47 dm <sup>3</sup>
		<b>Sub-packaging description</b>	Carton tray
		<b>Sub-packaging quantity</b>	1 Pcs
		<b>Sub-packaging EAN barcode</b>	8015747292696

Part number

# CGC 24 G



Catalogue drawings

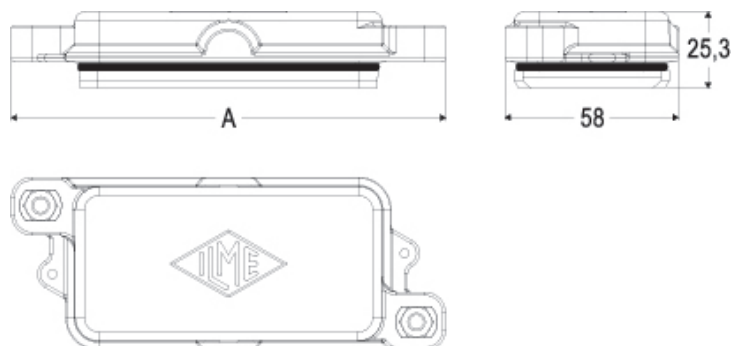

part No.	polarity	A
CGC 06 G	06	132,5
CGC 10 G	10	145,5
CGC 16 G	16	165,5
CGC 24 G	24	192,5

Catalogue drawings

Loop, for fixing on hoods



Notes