

Part number

CDM 40

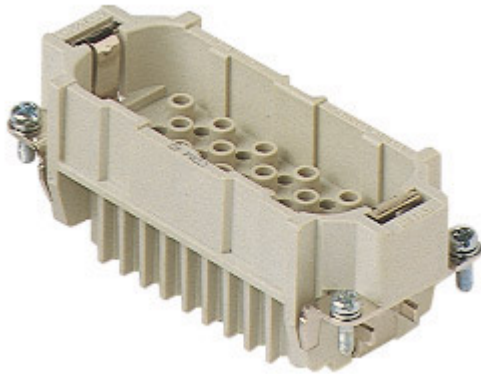

Male insert, CD series, crimp connection, 40 poles + PE, 10 A 250 V 4 kV 3, size "77.27"

Product description	
Product type	Insert
Series	CD
Connection type	Crimp connection
Gender	Male
N. of poles	40 poles +
Size	Size 77.27
Technical data	
Current	10 A
Voltage	250 V
Rated impulse withstand voltage	4 kV
Pollution degree	3
Rated voltage according to UL/CSA	600 V
IP degree of protection	IP20 without enclosure, IP65/IP66/IP68/IP69 with enclosure
Further technical details	
Characteristics according to EN 61984	10A 250V 4kV 3; 10A 230/400V 4kV 2
Mating cycles	≥ 500
Insulation resistance	≥ 10 GΩ
Contact resistance	≤ 3 mΩ
Weight	54,00 g
Operating temperature range (min, max)	-40 °C ... +125 °C
Conductors stripping length	6 - 8 mm
UL 94 flammability rating	V-0
Tightening torque for PE connection	M4: 1,2 Nm, 10,6 lb.in (Ph2 or 1,0x5,5mm)
Tightening torque for fixing screws	M3: 0.5 Nm; 4.4 lb.in (Ph1 or 0.8x4 mm)

Material properties	
Main material	Polycarbonate (PC)
Colour	RAL 7032 grey
RoHs conformity	Compliant
China RoHs - EFUP	E
REACH SVHC substances	No
Approvals / Standards	
Reference standard	EN 61984:2009-06
Certifications	CSAc, CQC, DNV, BV, EAC
UL	ECBT2
cUL	ECBT8
General ordering information	
EAN13 code	8015747015141
eCl@ss 8.1	27440205
ETIM 7.0	EC000438
Packaging Information	
Packaging length	230,00 mm
Packaging height	110,00 mm
Packaging width	180,00 mm
Packaging weight	2,03 kg
Packaging volume	4,55 dm ³
Packaging description	Carton box
Packaging quantity	30 Pcs
Packaging EAN code	8015747015158
Sub-packaging length	87,00 mm
Sub-packaging height	36,00 mm
Sub-packaging width	180,00 mm
Sub-packaging weight	0,34 kg
Sub-packaging volume	0,56 dm ³
Sub-packaging description	Carton tray
Sub-packaging quantity	5 Pcs
Sub-packaging EAN barcode	8015747015165

Part number

CDM 40



Catalogue drawings

CDM 40

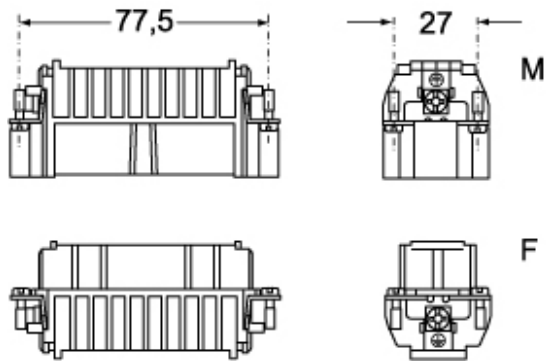

CDF 40

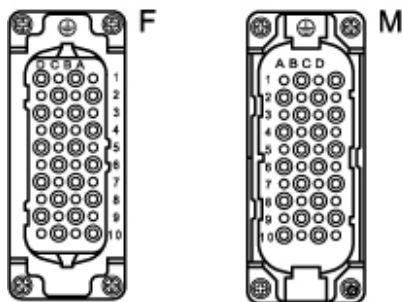

Catalogue drawings

diagram CD 40 and 80 poles

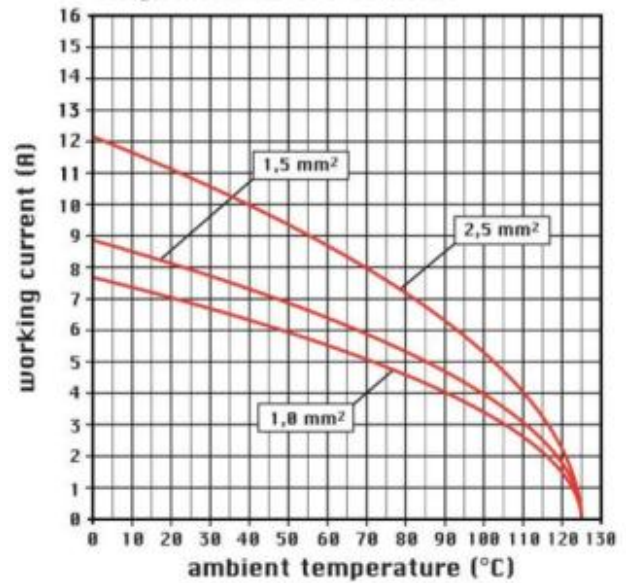

Notes

California Proposition 65 Information



WARNING

This product can expose you to nickel compounds, known to the State of California to cause cancer and/or reproductive toxicity. For more information go to www.P65Warnings.ca.gov.