

Part number

CAV 24 LG21



Hood, C-TYPE series, with 1 lever, Pg21 top cable entry, size "104.27", high construction

Product description		Material properties	
Product type	Hood	Other materials	Lever: Stainless steel, polyamide (PA) Gasket: NBR
Series	C-TYPE	Colour	RAL 7040 grey
Closing type	With 1 lever		Compliant with exemption
Size	Size 104.27	RoHs conformity	6(c): copper alloy containing up to 4% lead by weight
Cable entry	Top cable entry with adapter Pg21	China RoHs - EFUP	50
Specification	High construction	REACH SVHC substances	Yes Lead
Technical data		SCIP number	15deaf78-e939-4401-a0b0-e2228ca32a03
IP degree of protection	IP65 / IP66 / IP69	Approvals / Standards	
Further technical details		Certifications	DNV, BV
Weight	360,00 g	UL	ECBT2
Operating temperature range (min, max)	-40°C...+125°C	cUL	ECBT8
		General ordering information	
		EAN13 code	8015747010016
		Packaging Information	
		Packaging length	305,00 mm
		Packaging height	180,00 mm
		Packaging width	275,00 mm
		Packaging weight	3,90 kg
		Packaging volume	15,10 dm ³
		Packaging description	Carton box
		Packaging quantity	10 Pcs
		Packaging EAN code	8015747226165
		Sub-packaging weight	1,95 kg
		Sub-packaging description	Plastic packaging
		Sub-packaging quantity	5 Pcs
		Sub-packaging EAN barcode	8015747010023

Part number

CAV 24 LG21



Catalogue drawings

**CHO L (CAO L) - MHO L [MAO L]
CHV L [CAV L] - MHV L (MAV L)**



CHV LG (CAV LG), MHV LG (MAV LG) [MFV LG]

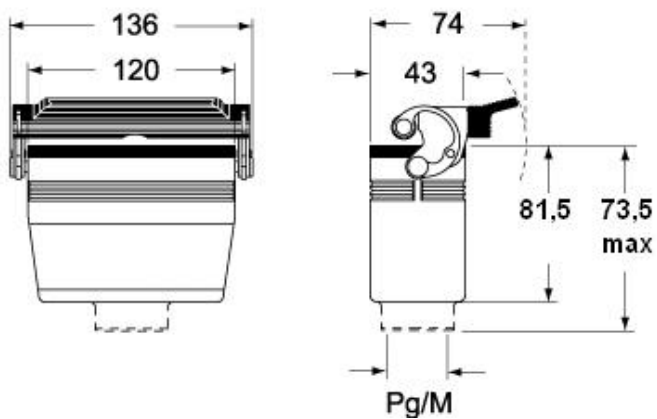

Notes