

Part number

AH M25IFL



Complete cable gland, M25, for diameter
15-18 mm

Product description		General ordering information	
Product type	Complete cable gland	EAN13 code	8015747262873
Cable entry	M25	eCl@ss 8.1	27149109
Specification	For diameter 15-18 mm For T-TYPE HYGIENIC	ETIM 7.0	EC000441
Technical data		Packaging Information	
IP degree of protection	IP68/IP69	Sub-packaging weight	0,22 kg
Further technical details		Sub-packaging description	Plastic packaging
Weight	44,00 g	Sub-packaging quantity	5 Pcs
Operating temperature range (min, max)	-20 °C...+85 °C	Sub-packaging EAN barcode	8015747262910

Part number

AH M25IFL



Catalogue drawings

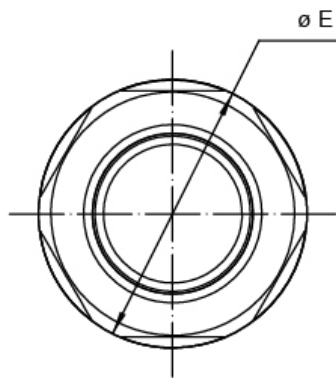
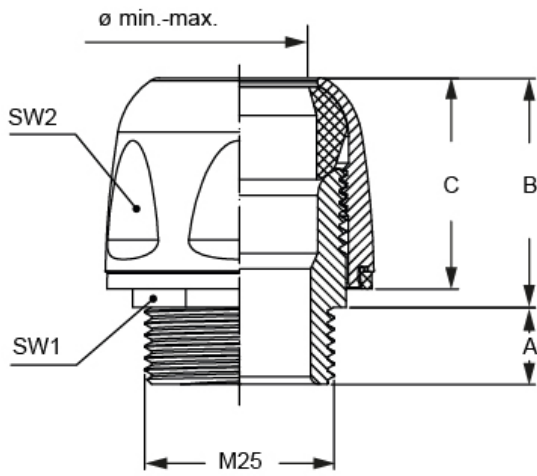

part No.	A	B	C	SW1	SW2	ø E	ø min.-max.
AH M25IF	10	30	27	24	32	34,9	12,0-15,0
AH M25IFL	10	30	27	24	32	34,9	15,0-18,0

Notes