

Part number

TMAV 16 G32



Hood, T-TYPE series, with 2 levers, M32 top cable entry, size "77.27"

Product description		Material properties	
Product type	Hood	Main material	Polypropylene (PP)
Series	T-TYPE	Other materials	Lever: Polyamide (PA) Gasket: polyurethane (PUR)
Closing type	With 2 levers	Colour	RAL 7012 grey, RAL 7001 grey
Size	Size 77.27	RoHs conformity	Compliant
Cable entry	Top cable entry M32	China RoHs - EFUP	E
Specification	High construction	REACH SVHC substances	No
Technical data		Approvals / Standards	
IP degree of protection	IP65	UL	ECBT2
Further technical details		cUL	ECBT8
Weight	178,50 g	General ordering information	
Operating temperature range (min, max)	-40°C ... +90°C	EAN13 code	8015747209083
		eCl@ss 8.1	27440202
		ETIM 7.0	EC000437
		Packaging Information	
		Packaging length	290,00 mm
		Packaging height	250,00 mm
		Packaging width	360,00 mm
		Packaging weight	3,92 kg
		Packaging volume	26,10 dm ³
		Packaging description	Carton box
		Packaging quantity	20 Pcs
		Packaging EAN code	8015747260800
		Sub-packaging weight	0,98 kg
		Sub-packaging description	Plastic packaging
		Sub-packaging quantity	5 Pcs
		Sub-packaging EAN barcode	8015747209168

Part number

TMAV 16 G32



Catalogue drawings

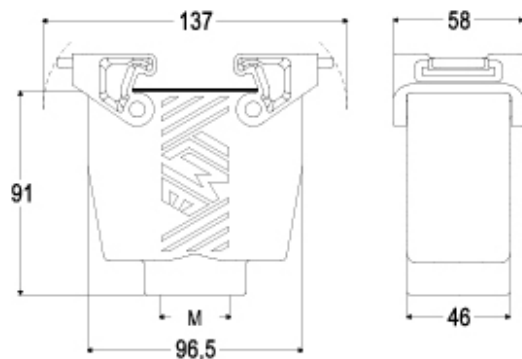

Notes

Dimensions shown in mm are not binding and may be changed without notice.
