

Part number

TM 6363 IS



Interlocked switched socket-outlet, TM series, 2 poles + PE, 6 h (blue), 63 A, 200 ÷ 250 V, sectionable fuse carrier 22 x 58 mm, with base box

Product description		Material properties	
Product type	Interlocked switched socket-outlet	Colour	RAL 7012 grey, RAL 5015 blue
Series	TM.. IS/KIS		Compliant with exemption 6(c): copper alloy containing up to 4% lead by weight
N. of poles	2 poles + 	RoHs conformity	6(c): copper alloy containing up to 4% lead by weight
Clock position	6	China RoHs - EFUP	50
Size	145 x 565 x 18 mm	REACH SVHC substances	Yes Lead
Specification	Sectionable fuse carrier 22 x 58 mm With base box	SCIP number	F6799547-ab84-42f2-938f-233ba663766d
Technical data		Approvals / Standards	
Current	63 A	Reference standard	EN 60309-1, -2 e -4
Voltage	200 ÷ 250 V	General ordering information	
IP degree of protection	IP66 / IP67	EAN13 code	8015747092487
Further technical details		Packaging Information	
Weight	3.545,00 g	Sub-packaging length	150,00 mm
Operating temperature range (min, max)	-25°C ... +40°C	Sub-packaging height	188,00 mm
UL 94 flammability rating	V-0 (insert), V-2 (enclosure)	Sub-packaging width	430,00 mm
IK rating (impact degree of protection)	IK10	Sub-packaging weight	3,55 kg
		Sub-packaging volume	12,13 dm ³
		Sub-packaging description	Carton box
		Sub-packaging quantity	1 Pcs
		Sub-packaging EAN barcode	8015747092500

Part number

TM 6363 IS



Catalogue drawings

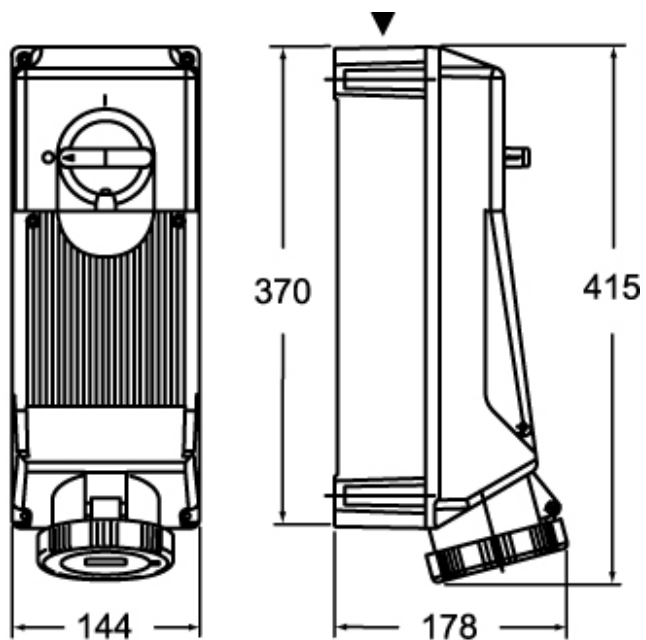

Notes

Dimensions shown in mm are not binding and may be changed without notice.