

Part number

TAPW 10.32



Surface mounting housing, T-TYPE /W series,
with 2 levers, M32 cable entry, size "57.27"

Product description		Material properties	
Product type	Surface mounting housing	Main material	Polypropylene (PP)
Series	T-TYPE /W	Other materials	Lever: Polyamide (PA) Gasket: FKM
Closing type	With 2 levers	Colour	RAL 7012 grey, RAL 7001 grey
Size	Size 57.27	RoHs conformity	Compliant
Cable entry	With cable entry M32	China RoHs - EFUP	E
Technical data		REACH SVHC substances	No
IP degree of protection	IP66 / IP69	Approvals / Standards	
Further technical details		UL	ECBT2
Weight	156,00 g	cUL	ECBT8
Operating temperature range (min, max)	-40°C ... +90°C	General ordering information	
		EAN13 code	8015747211710
		eCl@ss 8.1	27440202
		ETIM 7.0	EC000437
		Packaging Information	
		Packaging length	310,00 mm
		Packaging height	220,00 mm
		Packaging width	240,00 mm
		Packaging weight	3,40 kg
		Packaging volume	16,37 dm ³
		Packaging description	Carton box
		Packaging quantity	20 Pcs
		Packaging EAN code	8015747211826
		Sub-packaging weight	0,85 kg
		Sub-packaging description	Plastic packaging
		Sub-packaging quantity	5 Pcs
		Sub-packaging EAN barcode	8015747211833

Part number

TAPW 10.32



Catalogue drawings

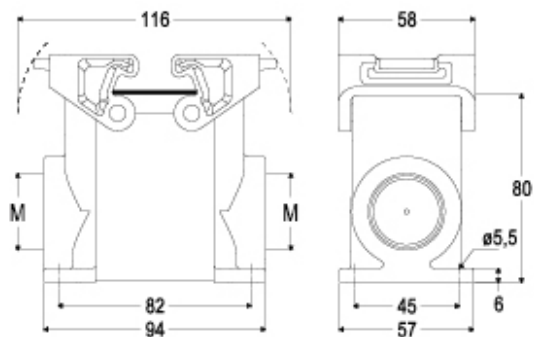

Notes

Dimensions shown in mm are not binding and may be changed without notice.
