

Part number

TAPH 06 L25

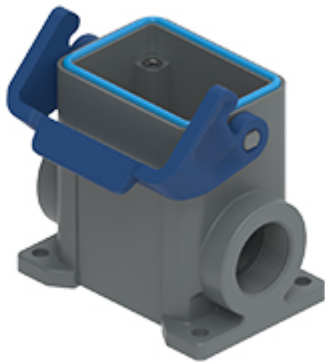

Surface mounting housing, T-TYPE /H series,
with 1 lever, M25 cable entry, size "44.27"

Product description		Material properties	
Product type	Surface mounting housing	Main material	Polypropylene (PP)
Series	T-TYPE /H	Other materials	Lever: Polypropylene (PP), metal-detectable Gasket: HNBR
Closing type	With 1 lever	Colour	RAL 7012 grey, RAL 5005 blue
Size	Size 44.27	RoHS conformity	Compliant
Cable entry	With cable entry M25	China RoHS - EFUP	E
Technical data		REACH SVHC substances	No
IP degree of protection	IP66 / IP69	General ordering information	
Further technical details		EAN13 code	8015747209878
Weight	133,00 g	eCl@ss 8.1	27440202
Operating temperature range (min, max)	-40°C ... +70°C	ETIM 7.0	EC000437
		Packaging Information	
		Packaging length	180,00 mm
		Packaging height	210,00 mm
		Packaging width	330,00 mm
		Packaging weight	3,15 kg
		Packaging volume	12,47 dm ³
		Packaging description	Carton box
		Packaging quantity	20 Pcs
		Packaging EAN code	8015747210010
		Sub-packaging weight	0,79 kg
		Sub-packaging description	Plastic packaging
		Sub-packaging quantity	5 Pcs
		Sub-packaging EAN barcode	8015747210027

Part number

TAPH 06 L25



Catalogue drawings

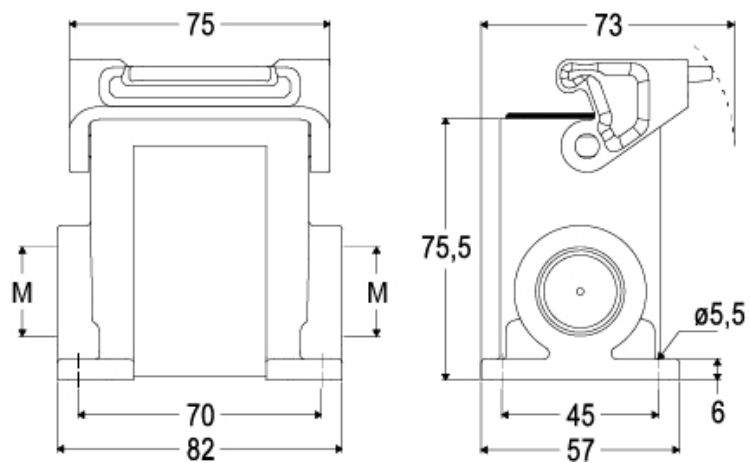

Notes

Dimensions shown in mm are not binding and may be changed without notice.