

Part number

SQE 3224.5



Interlocked switched socket-outlet, SQE series, 3 poles + PE, 2 h (green), 32 A, > 50 V, without fuse-carrier

Product description	
Product type	Interlocked switched socket-outlet
Series	SQE
N. of poles	3 poles + 
Clock position	2
Specification	Without fuse-carrier
Technical data	
Current	32 A
Voltage	> 50 V
IP degree of protection	IP55
Further technical details	
Operating temperature range (min, max)	-25°C ... +40°C
IK rating (impact degree of protection)	IK08

Material properties	
Colour	RAL 7035 grey, RAL 6017 green
Approvals / Standards	
Reference standard	EN 60309-1, -2 e -4
General ordering information	
EAN13 code	8015747159999

Part number

SQE 3224.5



Catalogue drawings

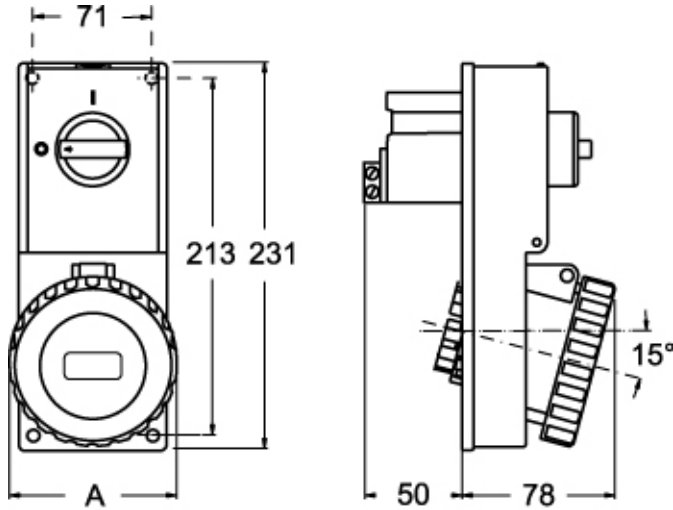

Catalogue drawings

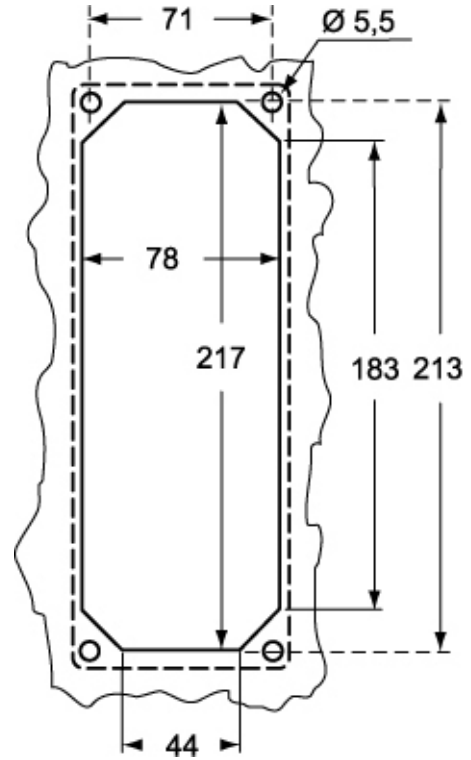

SQE.5		A
32A	2P+⊕	92
	3P+⊕	92
	3P+N+⊕	100

Notes

Dimensions shown in mm are not binding and may be changed without notice.