

Part number

SIF2D 0.2

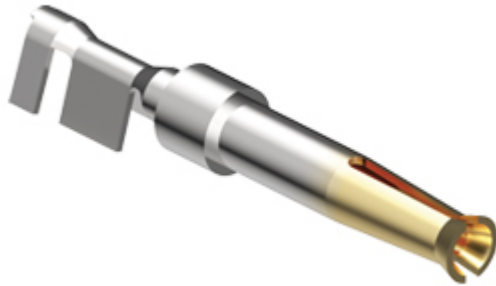

Female crimp contact, SI series, 5 A, stamped gold plated, wire cross section 0,08 - 0,21 mm², AWG 28 - 24, loose parts, for 250 mating cycles

Product description		Material properties	
Product type	Crimp contact	RoHs conformity	Compliant
Series	SI	China RoHs - EFUP	E
Gender	Female	REACH SVHC substances	No
Specification	Loose parts For 250 mating cycles	Approvals / Standards	
Technical data		Certifications	EAC
Current	5 A	UL	ECBT2
Wire cross-section	0,08 mm ² - 0,21 mm ²	cUL	ECBT8
AWG size	28 - 24	General ordering information	
Contact type	Stamped gold plated	EAN13 code	8015747272216
Further technical details		eCl@ss 8.1	27440204
Contact resistance	≤ 10 mΩ	ETIM 7.0	EC000796
Weight	0,11 g	Packaging Information	
Conductors stripping length	3 mm	Packaging length	112,00 mm
		Packaging height	95,00 mm
		Packaging width	117,00 mm
		Packaging weight	0,36 kg
		Packaging volume	1,24 dm ³
		Packaging description	Carton box
		Packaging quantity	1600 Pcs
		Packaging EAN code	8015747272261
		Sub-packaging length	50,00 mm
		Sub-packaging height	44,00 mm
		Sub-packaging width	50,00 mm
		Sub-packaging weight	0,05 kg
		Sub-packaging volume	0,11 dm ³
		Sub-packaging description	Plastic box
		Sub-packaging quantity	200 Pcs
		Sub-packaging EAN barcode	8015747272278

Part number

SIF2D 0.2



Catalogue drawings

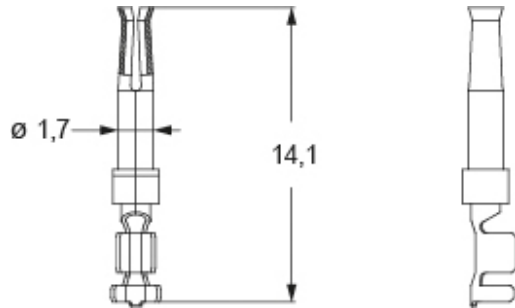

Notes

Dimensions shown in mm are not binding and may be changed without notice.

California Proposition 65 Information



WARNING

This product can expose you to nickel compounds, known to the State of California to cause cancer and/or reproductive toxicity. For more information go to www.P65Warnings.ca.gov.